

### Subminiature Basic Switch Offers Long Life and High Reliability

- A design that combines simplicity and stability by the use of two split springs ensures a long durability of 30,000,000 operations.
- A variety of models are available, with operating force ranging from low to high.
- Available by 10.1 A, 5 A, and 0.1 A models.

RoHS Compliant



## Ordering Information

### ■ Model Number Legend

SS-

1	2	3	4	5	6

#### 1. Ratings

10: 10.1 A at 125 VAC  
5: 5 A at 125 VAC  
01: 0.1 A at 30 VDC

#### 2. Actuator

None: Pin plunger  
GL: Hinge lever  
GL13: Simulated roller lever  
GL2: Hinge roller lever

#### 3. Maximum Operating Force (see note 1)

None: 1.47 N {150 gf}  
-F: 0.49 N {50 gf} (0.1 A, 5 A)  
-E: 0.25 N {25 gf} (0.1 A)

**Note:** These values are for pin plunger models.

#### 4. Contact Form

None: SPDT  
-2: SPST-NC  
-3: SPST-NO

#### 5. Terminals



None: Solder terminals  
T: Quick-connect terminals (#110)  
D: PCB terminals (see note 2)



#### 6. Special Code

None: Standard (85°C)  
-T: Heat resistive (120°C)

## ■ List of Models





### Standard Models

Actuator	Terminal	Contact Form	Rating OF max.	10.1 A	5 A	0.1 A	
<b>Pin plunger</b> 	Solder terminal	SPDT	1.47 N {150 gf}	SS-10	SS-5	SS-01	
		SPST-NC		SS-10-2	SS-5-2	SS-01-2	
		CPST-NO		SS-10-3	SS-5-3	SS-01-3	
	Quick-connect terminal (#110)	SPDT		SS-10T	SS-5T	SS-01T	
		SPST-NC		SS-10-2T	SS-5-2T	SS-01-2T	
		CPST-NO		SS-10-3T	SS-5-3T	SS-01-3T	
	PCB terminal	SPDT		SS-10D	SS-5D	SS-01D	
		SPST-NC		SS-10-2D	SS-5-2D	SS-01-2D	
		CPST-NO		SS-10-3D	SS-5-3D	SS-01-3D	
	Solder terminal	SPDT	0.49 N {50 gf}	---	SS-5-F	SS-01-F	
		SPST-NC		---	SS-5-F-2	SS-01-F-2	
		CPST-NO		---	SS-5-F-3	SS-01-F-3	
	Quick-connect terminal (#110)	SPDT		---	SS-5-FT	SS-01-FT	
		SPST-NC		---	SS-5-F-2T	SS-01-F-2T	
		CPST-NO		---	SS-5-F-3T	SS-01-F-3T	
	PCB terminal	SPDT		---	SS-5-FD	SS-01-FD	
		SPST-NC		---	SS-5-F-2D	SS-01-F-2D	
		CPST-NO		---	SS-5-F-3D	SS-01-F-3D	
	Solder terminal	SPDT	0.25 N {25 gf}	---	---	SS-01-E	
		SPST-NC		---	---	SS-01-E-2	
		CPST-NO		---	---	SS-01-E-3	
	Quick-connect terminal (#110)	SPDT		---	---	SS-01-ET	
		SPST-NC		---	---	SS-01-E-2T	
		CPST-NO		---	---	SS-01-E-3T	
	PCB terminal	SPDT		---	---	SS-01-ED	
		SPST-NC		---	---	SS-01-E-2D	
		CPST-NO		---	---	SS-01-E-3D	
	<b>Hinge lever</b> 	Solder terminal	SPDT	0.49 N {50 gf}	SS-10GL	SS-5GL	SS-01GL
			SPST-NC		SS-10GL-2	SS-5GL-2	SS-01GL-2
			CPST-NO		SS-10GL-3	SS-5GL-3	SS-01GL-3
Quick-connect terminal (#110)		SPDT	SS-10GLT		SS-5GLT	SS-01GLT	
		SPST-NC	SS-10GL-2T		SS-5GL-2T	SS-01GL-2T	
		CPST-NO	SS-10GL-3T		SS-5GL-3T	SS-01GL-3T	
PCB terminal		SPDT	SS-10GLD		SS-5GLD	SS-01GLD	
		SPST-NC	SS-10GL-2D		SS-5GL-2D	SS-01GL-2D	
		CPST-NO	SS-10GL-3D		SS-5GL-3D	SS-01GL-3D	
Solder terminal		SPDT	0.16 N {16 gf}	---	SS-5GL-F	SS-01GL-F	
		SPST-NC		---	SS-5GL-F-2	SS-01GL-F-2	
		CPST-NO		---	SS-5GL-F-3	SS-01GL-F-3	
Quick-connect terminal (#110)		SPDT		---	SS-5GL-FT	SS-01GL-FT	
		SPST-NC		---	SS-5GL-F-2T	SS-01GL-F-2T	
		CPST-NO		---	SS-5GL-F-3T	SS-01GL-F-3T	

Actuator	Terminal	Contact Form	Rating OF max.	10.1 A	5 A	0.1 A	
<b>Hinge lever</b> 	PCB terminal	SPDT	0.16 N {16 gf}	---	SS-5GL-FD	SS-01GL-FD	
		SPST-NC		---	SS-5GL-F-2D	SS-01GL-F-2D	
		CPST-NO		---	SS-5GL-F-3D	SS-01GL-F-3D	
	Solder terminal	SPDT	0.08 N {8 gf}	---	---	SS-01GL-E	
		SPST-NC		---	---	SS-01GL-E-2	
		CPST-NO		---	---	SS-01GL-E-3	
	Quick-connect terminal (#110)	SPDT	0.08 N {8 gf}	---	---	SS-01GL-ET	
		SPST-NC		---	---	SS-01GL-E-2T	
		CPST-NO		---	---	SS-01GL-E-3T	
	PCB terminal	SPDT	0.08 N {8 gf}	---	---	SS-01GL-ED	
		SPST-NC		---	---	SS-01GL-E-2D	
		CPST-NO		---	---	SS-01GL-E-3D	
	<b>Simulated roller lever</b> 	Solder terminal	SPDT	0.49 N {50 gf}	SS-10GL13	SS-5GL13	SS-01GL13
			SPST-NC		SS-10GL13-2	SS-5GL13-2	SS-01GL13-2
			CPST-NO		SS-10GL13-3	SS-5GL13-3	SS-01GL13-3
Quick-connect terminal (#110)		SPDT	0.49 N {50 gf}	SS-10GL13T	SS-5GL13T	SS-01GL13T	
		SPST-NC		SS-10GL13-2T	SS-5GL13-2T	SS-01GL13-2T	
		CPST-NO		SS-10GL13-3T	SS-5GL13-3T	SS-01GL13-3T	
PCB terminal		SPDT	0.49 N {50 gf}	SS-10GL13D	SS-5GL13D	SS-01GL13D	
		SPST-NC		SS-10GL13-2D	SS-5GL13-2D	SS-01GL13-2D	
		CPST-NO		SS-10GL13-3D	SS-5GL13-3D	SS-01GL13-3D	
Solder terminal		SPDT	0.16 N {16 gf}	---	SS-5GL13-F	SS-01GL13-F	
		SPST-NC		---	SS-5GL13-F-2	SS-01GL13-F-2	
		CPST-NO		---	SS-5GL13-F-3	SS-01GL13-F-3	
Quick-connect terminal (#110)		SPDT	0.16 N {16 gf}	---	SS-5GL13-FT	SS-01GL13-FT	
		SPST-NC		---	SS-5GL13-F-2T	SS-01GL13-F-2T	
		CPST-NO		---	SS-5GL13-F-3T	SS-01GL13-F-3T	
PCB terminal		SPDT	0.16 N {16 gf}	---	SS-5GL13-FD	SS-01GL13-FD	
		SPST-NC		---	SS-5GL13-F-2D	SS-01GL13-F-2D	
		CPST-NO		---	SS-5GL13-F-3D	SS-01GL13-F-3D	
Solder terminal		SPDT	0.08 N {8 gf}	---	---	SS-01GL13-E	
		SPST-NC		---	---	SS-01GL13-E-2	
		CPST-NO		---	---	SS-01GL13-E-3	
Quick-connect terminal (#110)		SPDT	0.08 N {8 gf}	---	---	SS-01GL13-ET	
		SPST-NC		---	---	SS-01GL13-E-2T	
		CPST-NO		---	---	SS-01GL13-E-3T	
PCB terminal		SPDT	0.08 N {8 gf}	---	---	SS-01GL13-ED	
		SPST-NC		---	---	SS-01GL13-E-2D	
		CPST-NO		---	---	SS-01GL13-E-3D	

Actuator	Terminal	Contact Form	Rating OF max.	10.1 A	5 A	0.1 A
<b>Hinge roller lever</b> 	Solder terminal	SPDT	0.49 N {50 gf}	SS-10GL2	SS-5GL2	SS-01GL2
		SPST-NC		SS-10GL2-2	SS-5GL2-2	SS-01GL2-2
		CPST-NO		SS-10GL2-3	SS-5GL2-3	SS-01GL2-3
	Quick-connect terminal (#110)	SPDT		SS-10GL2T	SS-5GL2T	SS-01GL2T
		SPST-NC		SS-10GL2-2T	SS-5GL2-2T	SS-01GL2-2T
		CPST-NO		SS-10GL2-3T	SS-5GL2-3T	SS-01GL2-3T
	PCB terminal	SPDT		SS-10GL2D	SS-5GL2D	SS-01GL2D
		SPST-NC		SS-10GL2-2D	SS-5GL2-2D	SS-01GL2-2D
		CPST-NO		SS-10GL2-3D	SS-5GL2-3D	SS-01GL2-3D
	Solder terminal	SPDT	0.16 N {16 gf}	---	SS-5GL2-F	SS-01GL2-F
		SPST-NC		---	SS-5GL2-F-2	SS-01GL2-F-2
		CPST-NO		---	SS-5GL2-F-3	SS-01GL2-F-3
	Quick-connect terminal (#110)	SPDT		---	SS-5GL2-FT	SS-01GL2-FT
		SPST-NC		---	SS-5GL2-F-2T	SS-01GL2-F-2T
		CPST-NO		---	SS-5GL2-F-3T	SS-01GL2-F-3T
	PCB terminal	SPDT		---	SS-5GL2-FD	SS-01GL2-FD
		SPST-NC		---	SS-5GL2-F-2D	SS-01GL2-F-2D
		CPST-NO		---	SS-5GL2-F-3D	SS-01GL2-F-3D
	Solder terminal	SPDT	0.08 N {8 gf}	---	---	SS-01GL2-E
		SPST-NC		---	---	SS-01GL2-E-2
		CPST-NO		---	---	SS-01GL2-E-3
	Quick-connect terminal (#110)	SPDT		---	---	SS-01GL2-ET
		SPST-NC		---	---	SS-01GL2-E-2T
		CPST-NO		---	---	SS-01GL2-E-3T
	PCB terminal	SPDT		---	---	SS-01GL2-ED
		SPST-NC		---	---	SS-01GL2-E-2D
		CPST-NO		---	---	SS-01GL2-E-3D

## Heat resistive models

Actuator	Terminal	Contact Form	Rating OF max.	10.1 A	5 A	0.1 A
<b>Pin plunger</b> 	Solder terminal	SPDT	1.47 N {150 gf}	SS-10-T	SS-5-T	SS-01-T
	Quick-connect			SS-10T-T	SS-5T-T	SS-01T-T
	PCB terminal			SS-10D-T	SS-5D-T	SS-01D-T
<b>Hinge lever</b> 	Solder terminal	SPDT	0.49 N {50 gf}	SS-10GL-T	SS-5GL-T	SS-01GL-T
	Quick-connect			SS-10GLT-T	SS-5GLT-T	SS-01GLT-T
	PCB terminal			SS-10GLD-T	SS-5GLD-T	SS-01GLD-T
<b>Simulated roller lever</b> 	Solder terminal	SPDT	0.49 N {50 gf}	SS-10GL13-T	SS-5GL13-T	SS-01GL13-T
	Quick-connect			SS-10GL13T-T	SS-5GL13T-T	SS-01GL13T-T
	PCB terminal			SS-10GL13D-T	SS-5GL13D-T	SS-01GL13D-T
<b>Hinge roller lever</b> 	Solder terminal	SPDT	0.49 N {50 gf}	SS-10GL02-T	SS-5GL02-T	SS-01GL02-T
	Quick-connect			SS-10GL02T-T	SS-5GL02T-T	SS-01GL02T-T
	PCB terminal			SS-10GL02D-T	SS-5GL02D-T	SS-01GL02D-T

# Specifications

## ■ Ratings

Model	Rated voltage	Item	Resistive load
SS-10	250 VAC		10.1 A
SS-5	125 VAC		5 A
	250 VAC		3 A
SS-01	125 VAC		0.1 A
	30 VDC		0.1 A

**Note:** The ratings values apply under the following test conditions:  
 Ambient temperature: 20±2°C  
 Ambient humidity: 65±5%  
 Operating frequency: 30 operations/min

## ■ Characteristics

<b>Operating speed</b>	0.1 mm to 1 m/s (pin plunger models)
<b>Operating frequency</b>	Mechanical:400 operations/min max. Electrical:30 operations/min max.
<b>Insulation resistance</b>	100 MΩ min. (at 500 VDC)
<b>Contact resistance (initial value)</b>	OF 1.47 N {150 gf}: SS-10, SS-5 models:30 mΩ max. SS-01 models:50 mΩ max. OF 0.49 N {50 gf}: SS-5 models:50 mΩ max. SS-01 models:100 mΩ max. OF 0.25 N {25 gf}: SS-01 models:150 mΩ max.
<b>Dielectric strength (see note 2)</b>	1,000 VAC (600 VAC for SS-01 models), 50/60 Hz for 1 min between terminals of the same polarities 1,500 VAC, 50/60 Hz for 1 min between current-carrying metal part and ground, and between each terminal and non-current-carrying metal part
<b>Vibration resistance (see note 3)</b>	Malfunction: 10 to 55 Hz, 1.5-mm double amplitude
<b>Shock resistance (see note 4)</b>	Destruction: OF 1.47 N {150 gf}:1,000 m/s <sup>2</sup> {approx. 100G} max. OF 0.25 N {25gf}/0.49 N {50 gf}:500 m/s <sup>2</sup> {approx. 50G} max. Malfunction: OF 1.47 N {150 gf}:300 m/s <sup>2</sup> {approx. 30G} max. OF 0.25 N {25 gf}/0.49 N {50 gf}:200 m/s <sup>2</sup> {approx. 20G} max.
<b>Durability (see note 5)</b>	Mechanical: 30,000,000 operations min. (60 operations/min) (Refer to the following <i>Engineering Data</i> .) 10,000,000 operations min. (60 operations/min) for SS-10 models Electrical: 200,000 operations min. (30 operations/min) (Refer to the following <i>Engineering Data</i> .) 50,000 operations min. (30 operations/min) for SS-10 models
<b>Degree of protection</b>	IEC IP40
<b>Degree of protection against electrical shock</b>	Class I
<b>Proof Tracking Index (PTI)</b>	175
<b>Ambient operating temperature</b>	-25°C to 85°C (at ambient humidity of 60% max.) (with no icing or condensation)
<b>Ambient operating humidity</b>	85% max. (for 5°C to 35°C)
<b>Weight</b>	Approx. 1.6 g (pin plunger models)

**Note:** 1. The data given above are initial values.  
 2. The dielectric strength shown in the table indicates a value for models with a Separator.  
 3. For the pin plunger models, the above values apply for use at both the free position and total travel position. For the lever models, they apply at the total travel position.  
 4. Lever-type models: Total travel position (with a contact separation time of 1 ms max.)  
 5. For testing conditions, contact your OMRON sales representative.

### ■ Approved Standards

Consult your OMRON sales representative for specific models with standard approvals.

#### UL1054 (File No. E41515)/CSA C22.2 No. 55 (File No. LR21642)

Rated voltage	SS-10	SS-5	SS-01
125 VAC	---	5 A	0.1 A
250 VAC	10.1 A	3 A	---
30 VDC	---	---	0.1 A

#### EN61058-1 (File No. 129246 for SS-5, 125256 for SS-10, VDE approval)

Rated voltage	SS-10	SS-5
250 VAC	10 A	5 A

Testing conditions: 5E4 (50,000 operations); T85 (0°C to 85°C).

### ■ Contact Specifications

Item	SS-10	SS-5	SS-01	
Contact	Specification	Rivet		
	Material	Silver alloy	Silver	Gold alloy
	Gap (standard value)	0.5 mm		0.25 mm
Inrush current	NC	20 A max.		
	NO	15 A max.	10 A max.	1 A max.
Minimum applicable load (see note)	160 mA at 5 VDC		1 mA at 5 VDC	

**Note:** For more information on the minimum applicable load, refer to *Using Micro Loads* on page 9.

### ■ Contact Form

#### SPDT

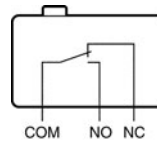

#### SPST-NC

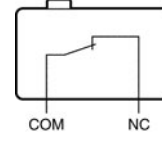

#### SPST-NO

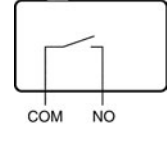

## Dimensions

**Note:** All units are in millimeters unless otherwise indicated.

### ■ Terminals

Terminal plate thickness is 0.5 mm for all models.

#### Solder Terminals

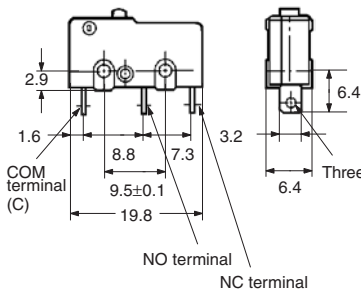

#### Quick-connect Terminals (#110)

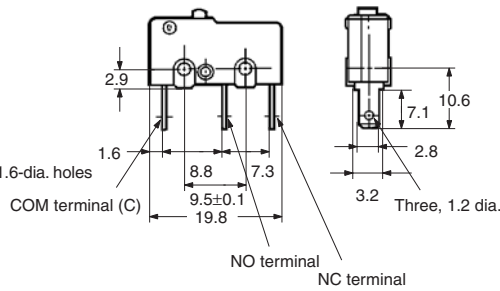

#### PCB Terminals

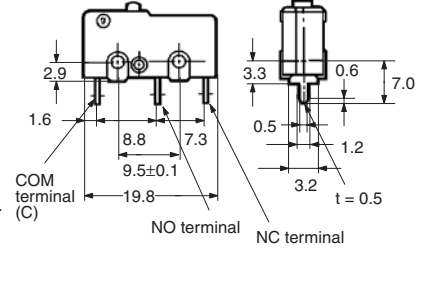

#### PCB Mounting Dimensions (Reference)

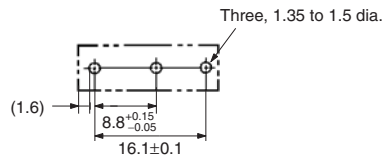

### ■ Mounting Holes

Two, 2.4-dia. mounting holes or M2.3 screw holes

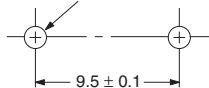

## ■ Dimensions and Operating Characteristics

- Note:**
- All units are in millimeters unless otherwise indicated.
  - The following illustration and drawing are for solder terminal models. Refer to page 6 for details on models with quick-connect terminals (#110) or PCB terminals.
  - Unless otherwise specified, a tolerance of  $\pm 0.4$  mm applies to all dimensions.
  - The operating characteristics are for operation in the A direction (▼).

### Pin Plunger Models

SS-10  
SS-5(-F)  
SS-01(-F, -E)

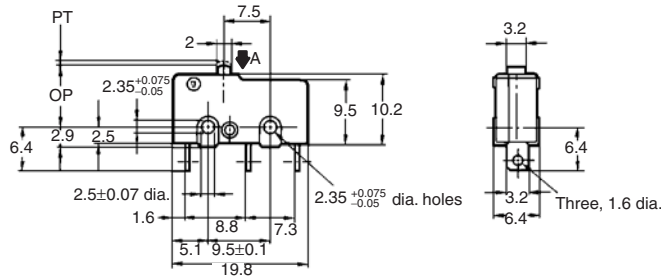
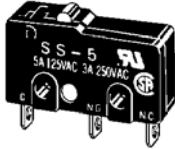

Model	SS-10	SS-5 SS-01	SS-5-F SS-01-F	SS-01-E
OF max.	1.47 N {150 gf}	1.47 N {150 gf}	0.49 N {50 gf}	0.25 N {25 gf}
RF min.	0.25 N {25 gf}	0.25 N {25 gf}	0.04 N {4 gf}	0.02 N {2 gf}
PT max.	0.6 mm	0.5 mm	0.5 mm	0.5 mm
OT min.	0.4 mm	0.5 mm	0.5 mm	0.5 mm
MD max.	0.12 mm	0.1 mm	0.1 mm	0.1 mm
OP	8.4±0.5 mm			

### Hinge Lever Models

SS-10GL  
SS-5GL(-F)  
SS-01GL(-F, -E)

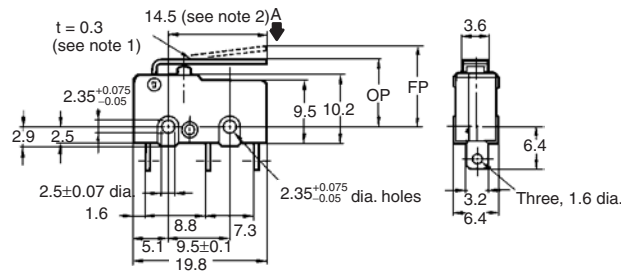
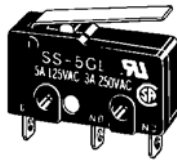

- Note:**
- Stainless-steel lever
  - Besides the SS-□GL models with a hinge lever length of 14.5, the SS-□GL11 models with a hinge lever length of 18.5, the SS-□GL111 models with a hinge lever length of 22.6, and the SS-□GL1111 models with a hinge lever length of 37.8 are available. Contact your OMRON representative for these models

Model	SS-10GL	SS-5GL SS-01GL	SS-5GL-F SS-01GL-F	SS-01GL-E
OF max.	0.49 N {50 gf}	0.49 N {50 gf}	0.16 N {16 gf}	0.08 N {8 gf}
RF min.	0.06 N {6 gf}	0.06 N {6 gf}	0.02 N {2 gf}	0.01 N {1 gf} (reference value)
OT min.	1.0 mm	1.2 mm	1.2 mm	1.2 mm
MD max.	1.0 mm	0.8 mm	0.8 mm	0.8 mm
FP max.	13.6 mm			
OP	8.8±0.8 mm			

- Note:** The values indicated in parentheses are reference values for cases when the installation direction is such that the lever weight is not applied to the plunger.

**Simulated Roller Lever Models**

SS-10GL13  
 SS-5GL13(-F)  
 SS-01GL13(-F, -E)

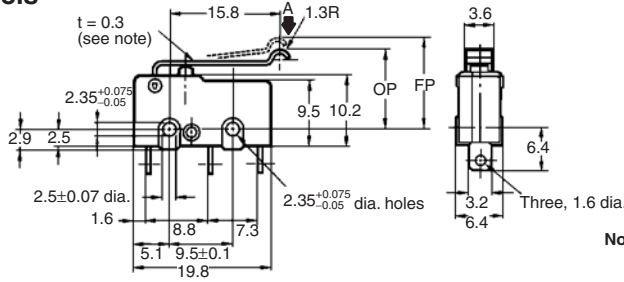
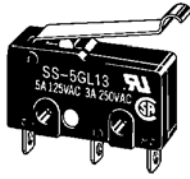

Note: Stainless-steel spring lever

Model	SS-10GL13	SS-5GL13 SS-01GL13	SS-5GL13-F SS-01GL13-F	SS-01GL13-E
OF max.	0.49 N {50 gf}	0.49 N {50 gf}	0.16 N {16 gf}	0.08 N {8 gf}
RF min.	0.06 N {6 gf}	0.06 N {6 gf}	0.02 N {2 gf}	0.01 N {1 gf} (reference value)
OT min.	1.0 mm	1.2 mm	1.2 mm	1.2 mm
MD max.	1.0 mm	0.8 mm	0.8 mm	0.8 mm
FP max.	15.5 mm			
OP	10.7±0.8 mm			

Note: The values indicated in parentheses are reference values for cases when the installation direction is such that the lever weight is not applied to the plunger.

**Hinge Roller Lever Models**

SS-10GL2  
 SS-5GL2(-F)  
 SS-01GL2(-F, -E)

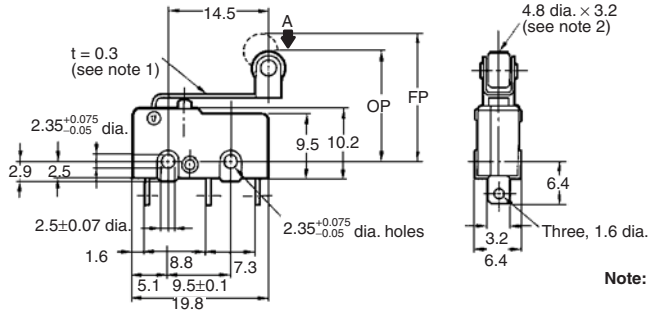
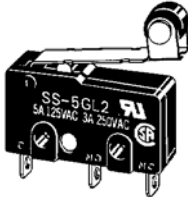

Note: 1. Stainless-steel spring lever  
 2. Polyacetal resin roller

Model	SS-10GL2	SS-5GL2 SS-01GL2	SS-5GL2-F SS-01GL2-F	SS-01GL2-E
OF max.	0.49 N {50 gf}	0.49 N {50 gf}	0.16 N {16 gf}	0.08 N {8 gf}
RF min.	0.06 N {6 gf}	0.06 N {6 gf}	0.02 N {2 gf}	0.01 N {1 gf} (reference value)
OT min.	1.0 mm	1.2 mm	1.2 mm	1.2 mm
MD max.	1.0 mm	0.8 mm	0.8 mm	0.8 mm
FP max.	19.3 mm			
OP	14.5±0.8 mm			

Note: The values indicated in parentheses are reference values for cases when the installation direction is such that the lever weight is not applied to the plunger.



# Precautions

Refer to *General Information*.

## ■ Cautions

### Terminal Connection

When soldering the lead wire to the terminal, first insert the lead wire conductor through the terminal hole and then conduct soldering.

Make sure that the capacity of the soldering iron is 60 W maximum. Do not take more than 350°C for the temperature at the tip of the soldering iron. Do not take more than 5 s to solder the switch terminal. Improper soldering involving an excessively high temperature or excessive soldering time may deteriorate the characteristics of the Switch.

Be sure to apply only the minimum required amount of flux. The Switch may have contact failures if flux intrudes into the interior of the Switch.

Use the following lead wires to connect to the solder terminals.

Model	Conductor size
SS-5	0.5 to 0.75 mm <sup>2</sup>
SS-10	0.75 mm <sup>2</sup>

If the PCB terminal models are soldered in the solder bath, flux will permeate inside the Switch and cause contact failure. Therefore, manually solder the PCB terminal.

Wire the quick-connect terminals (#110) with receptacles. Insert the terminals straight into the receptacles. Do not impose excessive force on the terminal in the horizontal direction, otherwise the terminal may be deformed or the housing may be damaged.

### Insulation Distance

According to EN61058-1, the minimum insulation thickness for this Switch should be 1.1 mm and minimum clearance distance between the terminal and mounting plate should be 1.6 mm. If the insulation distance cannot be provided in the product incorporating the Switch, either use a Switch with insulation barrier or use a Separator to ensure sufficient insulation distance. Refer to Separator.

## ■ Correct Use

### Mounting

Turn OFF the power supply before mounting or removing the Switch, wiring, or performing maintenance or inspection. Failure to do so may result in electric shock or burning.

Use M2.3 mounting screws with plane washers or spring washers to securely mount the Switch. Tighten the screws to a torque of 0.23 to 0.26 N·m {2.3 to 2.7 kgf·cm}.

Mount the Switch onto a flat surface. Mounting on an uneven surface may cause deformation of the Switch, resulting in faulty operation or breakage in the housing.

### Operating Stroke Setting

Take particular care in setting the operating stroke for the pin plunger models. Make sure that the operating stroke is 70% to 100% of the rated OT distance. Do not operate the actuator exceeding the OT distance, otherwise the durability of the Switch may be shortened.

### Using Micro Loads

Using a model for ordinary loads to open or close the contact of a micro load circuit may result in faulty contact. Use models that operate in the following range. However, even when using micro load models within the operating range shown below, if inrush current occurs when the contact is opened or closed, it may increase contact wear and so decrease durability. Therefore, insert a contact protection circuit where necessary.

The minimum applicable load is the N-level reference value. This value indicates the malfunction reference level for the reliability level of 60% ( $\lambda$  60). The equation,  $\lambda$  60 =  $0.5 \times 10^{-6}$ /operations indicates that the estimated malfunction rate is less than 1/2,000,000 operations with a reliability level of 60%.

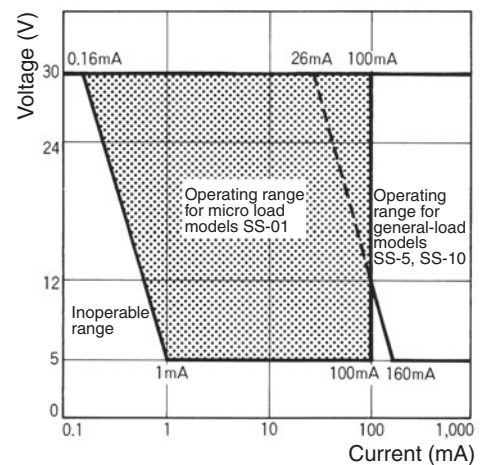

## ■ Separators

Applicable Switch	Thickness (mm)	Model (see note)
SS, D2S, D2SW	0.18	Separator for SS.018
	0.4	Separator for SS.04

### Separator for SS□

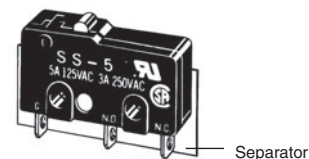

**Note:** The material is EAVTC (Epoxy Alkyd Varnished Tetrone Cloth) and its heat-resisting temperature is 130°C.

## ■ Connector

Refer to Terminal Connectors.

**ALL DIMENSIONS SHOWN ARE IN MILLIMETERS.**

To convert millimeters into inches, multiply by 0.03937. To convert grams into ounces, multiply by 0.03527.