

Syntax® is a Valentini srl registered trademark



**2019  
Edition**

# PowerSyntax® SPX SPZ CONNECTOR SERIES

Panel connector  
with microswitch  
**PATENT  
PENDING**



Quick release  
system  
**PATENT  
PENDING**



IP67  
covers



IP2X  
Drain lock  
**PATENTED**



**syntax**  
*connect to innovation*

6

**PATENT PENDING**  
Chain Pilot



This version of the panel-mount SPX connectors has a pilot microswitch built-in in the connector's body

10

**PATENT PENDING**  
SyntaxLock



Release system for the secondary lock on PowerSyntax connectors and IP67 protection caps. Supplied as an optional accessory, it can be retrofit on all PowerSyntax connectors

12

**IP67**  
Protection caps



Protection caps are now available in two versions, as a new range of IP67 waterproof caps has been introduced in addition to the IP53 caps that were already available

## ICONS Key

---



Chain Pilot (optional)  
Icon indicates items where Chain Pilot is available as an optional product version



SyntaxLock (optional)  
Icon indicates versions where SyntaxLock is available as an optional accessory



IP67 protection caps (optional)  
Icon indicates items where IP67 covers are available as an optional accessory



M5 fittings (optional)  
Icon indicates versions where M5 threaded fittings are available as an optional for rear panel-mount



IP2X drain contact lock (standard) **PATENTED**  
Icon indicates versions where drain contact lock is supplied as standard

## Line Source SPX

Innovative ergonomic hand grip for easy handling.  
 IP2X finger protection to prevent touching live parts.  
 Contact to housing retention through flame-retardant UL94-VO plastic cotter pin.  
 No special assembling tools needed.  
 Secondary locking safety system.  
 Set Screw termination for 25 mm<sup>2</sup> - 150 mm<sup>2</sup> cables.  
 Crimp termination for cables up to 300 mm<sup>2</sup>.  
 IP68 plastic cable gland for cable strain relief, with 15 - 32 mm (M40) or 30 - 38 mm (M50) clamping range.  
 Permanent phase/line identification and safety information markings embossed on connector's shell.  
 No additional information stickers applied.  
**SPX 4** 480amp with set screw contacts.  
**SPX 7** 750amp with crimp contacts.  
**SPY EasiLug** with bi-metal (aluminum/copper) or copper lug contact with crimp terminal.  
**SPV** with bi-metal (aluminum/copper) crimp contact.  
 For secondary lock release, use **SyntaxLock** or standard release key.

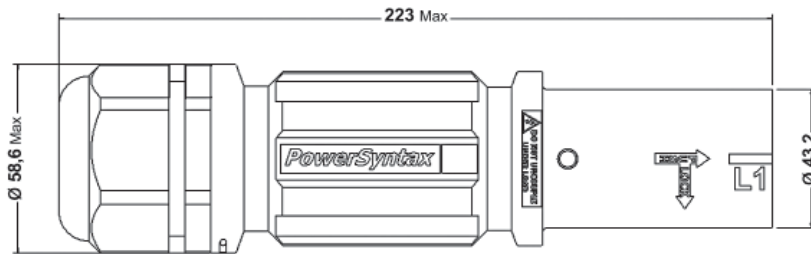

## Line Drain SPX

Innovative ergonomic hand grip for easy handling.  
 IP2X protection through patented drain contact lock.  
 Contact to housing retention through flame-retardant UL94-VO plastic cotter pin.  
 No special assembling tools needed.  
 Secondary locking safety system.  
 Set Screw termination for 25 mm<sup>2</sup> - 150 mm<sup>2</sup> cables.  
 Crimp termination for cables up to 300 mm<sup>2</sup>.  
 IP68 plastic cable gland for cable strain relief, with 15 - 32 mm (M40) or 30 - 38 mm (M50) clamping range.  
 Permanent phase/line identification and safety information markings embossed on connector's shell.  
 No additional information stickers applied.  
**SPX 4** 480amp with set screw contacts.  
**SPX 7** 750amp with crimp contacts.  
**SPY EasiLug** with bi-metal (aluminum/copper) or copper lug contact with crimp terminal.  
**SPV** with bi-metal (aluminum/copper) crimp contact.  
 For secondary lock release, use **SyntaxLock** or standard release key.

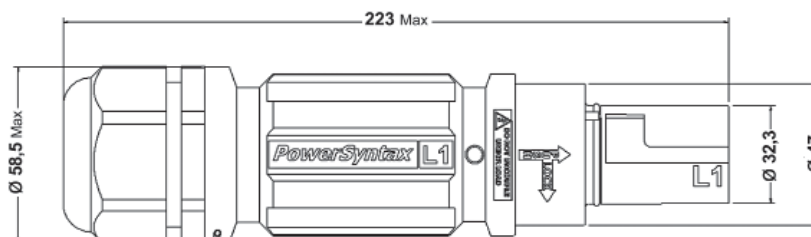



## Line Source SPZ

### SPZ short body version

Innovative ergonomic hand grip for easy handling.  
IP2X finger protection to prevent touching live parts.  
Contact to housing retention through flame-retardant UL94-VO plastic cotter pin.

No special assembling tools needed.  
Secondary locking safety system.

Set Screw termination for 25 mm<sup>2</sup> - 150 mm<sup>2</sup> cables.  
IP68 watertight M40 plastic cable gland for cable strain relief, with 15 - 32 mm clamping range.  
Permanent phase / line identification and safety information markings embossed on connector's shell.

No additional information stickers applied.

**SPZ 4** 480amp with set screw contacts.

For secondary lock release, use **SyntaxLock**

or standard release key.

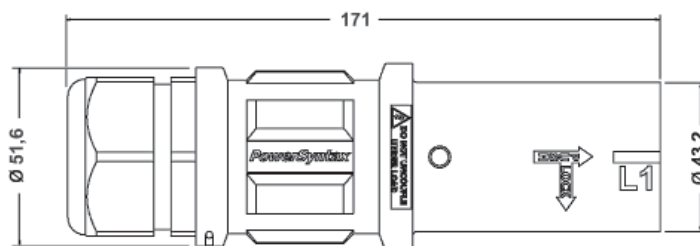

## Line Drain SPZ

### SPZ short body version

Innovative ergonomic hand grip for easy handling.  
IP2X protection through patented drain contact lock.  
Contact to housing retention through flame-retardant UL94-VO plastic cotter pin.

No special assembling tools needed.  
Secondary locking safety system.

Set Screw termination for 25 mm<sup>2</sup> - 150 mm<sup>2</sup> cables.  
IP68 watertight M40 plastic cable gland for cable strain relief, with 15 - 32 mm clamping range.  
Permanent phase / line identification and safety information markings embossed on connector's shell.

No additional information stickers applied.

**SPZ 4** 480amp with set screw contacts.

For secondary lock release, use **SyntaxLock**

or standard release key.

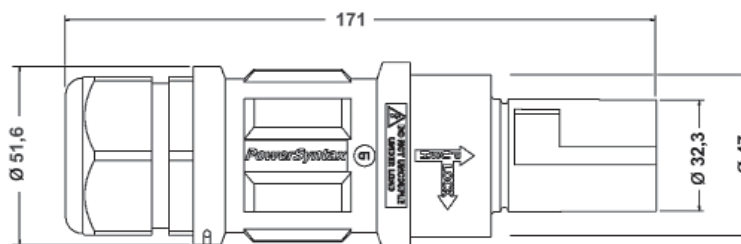

## Panel Source

Specific housing for protection cap lacing moulded on the plastic body of the flange.  
 IP2X finger protection to prevent touching live parts.  
 Contact to housing retention through flame-retardant UL94-VO plastic cotter pin.  
 No special assembling tools needed. Secondary locking safety system.  
 Front or rear panel mount. Optional M5 threaded fittings available for rear panel mount.  
 Permanent phase / line identification and safety information markings embossed on connector's shell.  
**SPX 4** 480amp and **SPX 7** 750amp versions available.  
 M12 contacts with M12 threaded post or M12 threaded hole.  
 Set screw, Crimp or EasiLug contacts available or request.  
 Threaded body with thermoplastic backshell and IP68 cable gland available.  
 For secondary lock release, use **SyntaxLock** or standard release key.

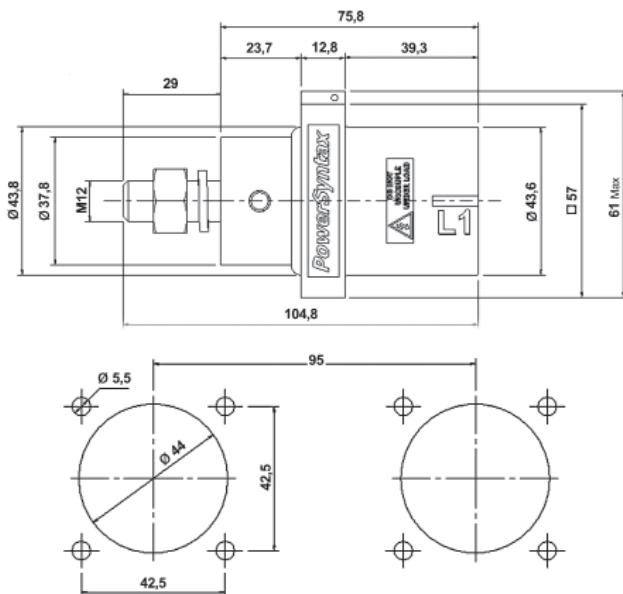

## Panel Drain

Specific housing for protection cap lacing moulded on the plastic body of the flange.  
 IP2X protection through patented drain contact lock.  
 Contact to housing retention through flame-retardant UL94-VO plastic cotter pin.  
 No special assembling tools needed. Secondary locking safety system.  
 Front or rear panel mount. Optional M5 threaded fittings available for rear panel mount.  
 Permanent phase / line identification and safety information markings embossed on connector's shell.  
**SPX 4** 480amp and **SPX 7** 750amp versions available.  
 M12 contacts with M12 threaded post or M12 threaded hole.  
 Set screw, Crimp or EasiLug contacts available or request.  
 Threaded body with thermoplastic backshell and IP68 cable gland available.  
 For secondary lock release, use **SyntaxLock** or standard release key.

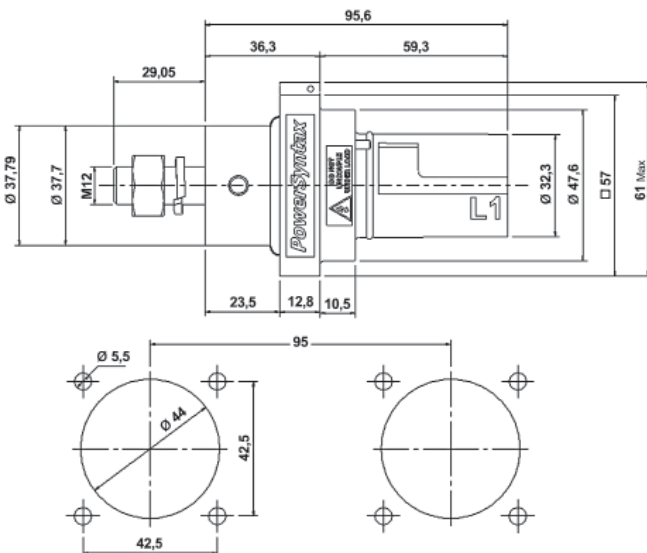

## Chain Pilot

Panel connector with microswitch

PATENT PENDING

This version of the panel-mount SPX connectors has a built-in pilot microswitch. The SPX chain pilot has been designed to obtain a protective electrical interlocking (or additional controls) through a chain of simultaneously operating connectors (see circuit diagrams on next page). When a panel connector is mated with its coupling cable connector, a spring device pressed by the thermoplastic insulated body edge of the cable connector is operated to activate the pilot microswitch housed in the rear of the flange. The SPX Chain Pilot version is available on both panel drain and panel source, 480amp and 750amp.

### Chain pilot panel drain

On the panel drain, the spring device activating the microswitch is placed outside the mating part of the connector's shell

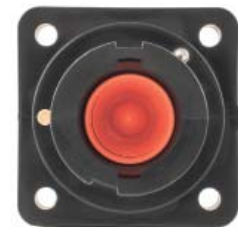

### Chain pilot panel source

On the panel source, the spring device activating the microswitch is placed inside the mating part of the connector's shell



## Pilot microswitch technical data

Switching function	Changeover switch (SPDT momentary)
Number of poles connections	1 - pole
Mechanical life endurance	10E6
Rating IEC / Rating North America	10 (3) A 250 V AC 10E3
Design	DIN 41635 B
Contact resistance (new condition)	< 100 (1 A 12 V DC) mOhm
Insulation resistance (new condition)	> 100 (500 V DC) MOhm
Voltage strength at 250 V	→ function insulation / basic insulation 1 500 V → small contact distance 500 V
Insulation spacing	acc. to EN 61058 for reinforced or double insulation
Flammability	UL 94 V-0
Glow wire test temperature	850 °C

## Wiring diagrams

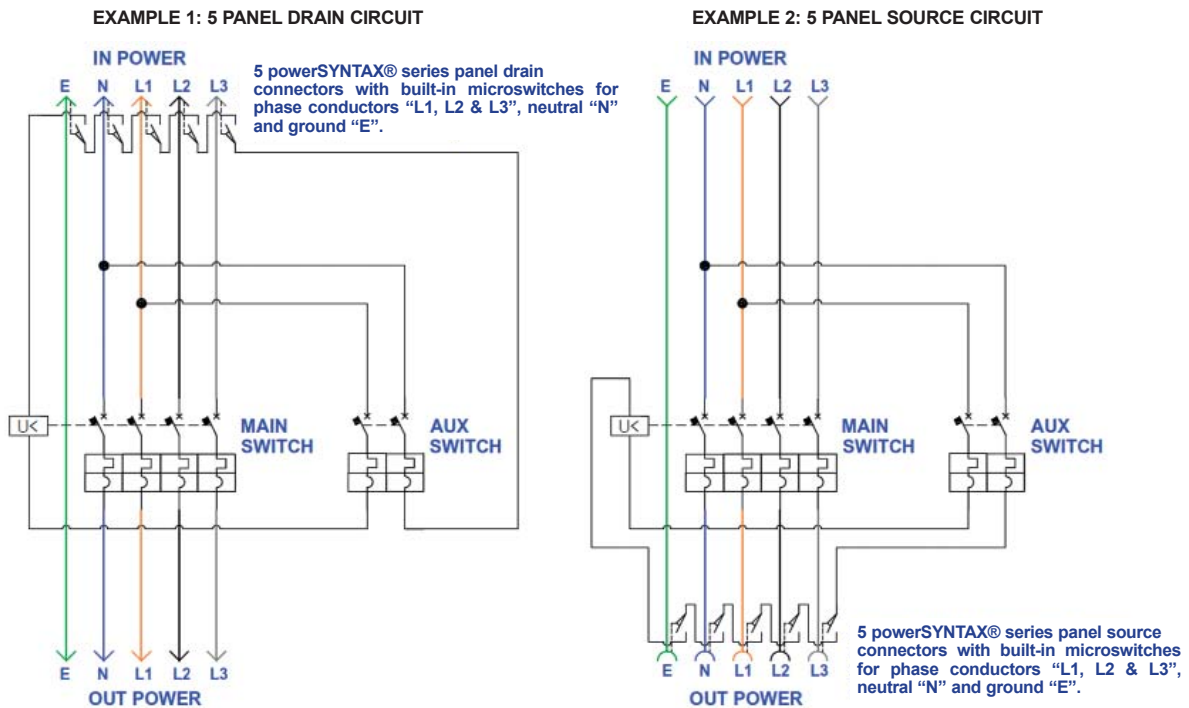

All diagrams are shown with circuits de-energised, all devices open in released position

## Panel mount cut-out options

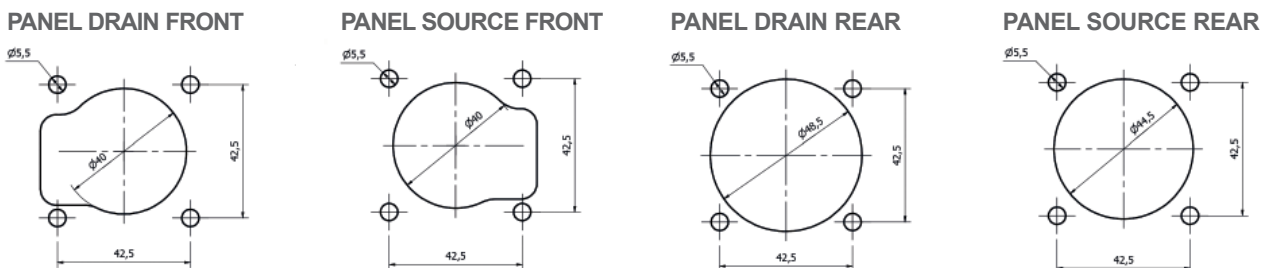

The SPX chain pilot panel drain / source can be front or rear mounted on panels. Cut-out dimensions are different for front and rear mount. Rear panel mount versions with M5 threaded fittings on request. Please contact our Technical Department for CAD drawings.

## A complete system of panel-mount connectors for PowerSyntax contacts

The PowerSyntax SPX panel drain/source connectors can be equipped with contact versions for different cable terminations, for up to 480amp or up to 750amp.

SPX panel connectors with M12 threaded post



As a standard, the PowerSyntax SPX panel-mount connectors are provided with fully assembled M12 threaded post contacts, suitable for connection to a standard cable lug. The M12 threaded post contacts are available for either 480amp or 750amp current rating.

SPX panel connectors with M12 threaded hole



As an alternative, the SPX panel-mount connectors can also be supplied with fully assembled M12 threaded hole contacts for fixing through a bolt. The M12 threaded hole contacts are available for either 480amp or 750amp current rating.

SPX panel connectors with set-screw / crimp contacts



This version of the panel-mount SPX PowerSyntax connectors is provided with a set screw or crimp terminal, depending on the cable section:

- Set-screw contact terminal with reduction sleeves for 25-150 mm<sup>2</sup> copper cables up to 480amp
- Crimp contact terminal for 185 – 240 mm<sup>2</sup> copper cables up to 750amp

SPX panel connectors with EasiLug contacts



This version of the panel-mount SPX PowerSyntax connectors is provided with copper or bi-metal aluminum/copper EasiLug contact:

- EasiLug contact with copper lug terminal for copper cables up to 750amp
- EasiLug contact with bi-metal aluminum/copper lug terminal for aluminum cables up to 480amp





## Connectors with threaded body and backshell

Panel connector with threaded body for insulating backshell fitting



The PowerSyntax SPX panel mount connectors are available with threaded body to fit a thermoplastic backshell. As well as the backshell, this system features an IP68 cable gland and provides IP67 watertight seal at the cable clamp. This version can be supplied with different contact terminal types:

- Set-screw contact terminal with reduction sleeves for 25-150 mm<sup>2</sup> copper cables up to 480 amp
- Crimp contact terminal for 185 – 240 mm<sup>2</sup> copper cables up to 750 amp
- EasiLug contact with copper lug terminal for copper cables up to 750 amp
- EasiLug contact with bi-metal aluminum/copper lug terminal for aluminum cables up to 480 amp

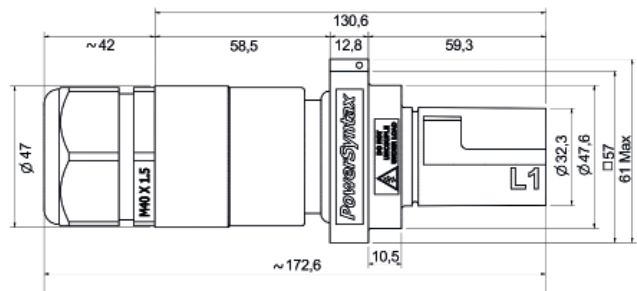
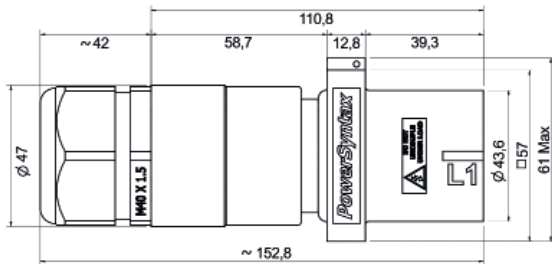

Set of 5 Panel Source connectors with backshell (panel rear view)



Set of 5 Panel Panel Drain connectors with backshell (panel rear view)



# SyntaxLock

PATENT PENDING

Suitable for all PowerSyntax connectors  
Can be fitted or removed at any time  
A simple, universal accessory  
Quick and easy to install



The SyntaxLock is a Syntax proprietary release system for the secondary lock on PowerSyntax connectors and IP67 protection caps. It eliminates the need for separate release keys that could be lost by technicians in everyday usage. In full compliance with the international electrical regulations, the connectors will be disconnected with a voluntary operation on the key (do not uncouple under load). Supplied as a separate accessory, the SyntaxLock is extremely easy to install and can be removed quickly from the connectors. The SyntaxLock can also be ordered as a retrofit accessory to be installed on all PowerSyntax connectors build as of 2011.



The SyntaxLock is supplied as a universal kit to be fitted on either line source or panel source connectors. The kit consists of:

- 1 collar (for line or panel source)
- 1 set of bolt / nut
- 1 release key for panel source
- 1 release key for line source

Order code: **SPX-SYLOCK**



SyntaxLock for  
Line Source



SyntaxLock for  
Panel Source

# SyntaxLock

PATENT PENDING



Line source equipped with SyntaxLock and IP67 cover



SyntaxLock assembled with key for Panel Source



Line drain equipped with IP67 cover and SyntaxLock



Panel source equipped with SyntaxLock and IP67 cover



SyntaxLock assembled with key for Line/Panel Drain cover



Panel drain equipped with IP67 cover and SyntaxLock



## SECONDARY LOCK AND RELEASE KEY

The secondary lock prevents unintentional disconnection under load. It is obtained through a locking pin on the drain connector which snaps into a slot on the mating source connector.



## Protection caps

Waterproof protection for PowerSyntax connectors



IP67

The PowerSyntax **IP67** caps ensure complete waterproof protection.

The PowerSyntax caps are universally keyed to be fitted on any connector's phase, so that just one cap version is needed respectively for Source and Drain connectors resulting in easier management and lower investment through reduced stock assortment. For full safety, the PowerSyntax IP67 caps feature the secondary locking system. The secondary lock will be released using SyntaxLock or a standard release key.



From top to bottom:  
IP67 protective cover for source  
IP67 protective cover for drain



From top to bottom:  
Panel source equipped with SyntaxLock and IP67 cover.  
Panel drain with IP67 cover (SyntaxLock mounted directly on cover).



Special housing on caps for lacing.  
Lacing through special high-resistance cable made up of seven stainless strands, and covered by anti-scratch teflon black tubing.

## Protection caps

Protective covers for PowerSyntax connectors



The IP53 caps are fast, easy way to protect PowerSyntax connectors. The use of protective caps results in:

- Extended life span of the connectors as the mating faces are protected against impact damage and abrasion
- Improved safety as contacts are protected against dust and water even when the connectors are not mated

## Protection caps lacing



On the PowerSyntax caps, all details have been designed with a strong focus on resistance and reliability.

A specific housing for the cap's lacing has been moulded directly on the flange of the panel-mount versions (photo 1) and on the body of the inline versions (photo 2). The caps are laced to the connector's body through a special high-resistance cable made up of seven stainless strands, and covered by anti-scratch teflon black tubing.



## Aluminium/copper bimetal contact for aluminium cable



The SPV bimetallic contact is obtained by the soldering of the aluminium and copper as raw materials.

The crimp terminal of the SPV contact is made of aluminium to allow corrosion-free termination onto aluminium cables.

Since the PowerSyntax® connectors were first introduced on the market, they have been used in a number of different applications from events to mobile generators to backup power systems. As well as improved safety compared to previous standards, for most users one of the main advantages of the PowerSyntax® has been its quick and easy connection.

SPX and SPZ standard PowerSyntax® connectors are suitable to be used with various copper cable sections. For some applications, though, there has been a demand that these connectors may be used with aluminium cable. However, as the standard PowerSyntax® connectors feature copper or copper based contacts, they should not be used for direct termination onto aluminium cables as galvanic corrosion and overheating may occur.

The aluminium/copper bimetal contact of the SPV allows the use of the PowerSyntax® connectors with aluminium cable, combining the advantages of this type of connection with the lighter weight associated with aluminium cable.



SPV 120-240  
- 480amp Source contact  
- Crimp termination  
- For cable up to 240 mm<sup>2</sup>



SPV 120-240  
- 480amp Drain contact  
- Crimp termination  
- For cable up to 240 mm<sup>2</sup>

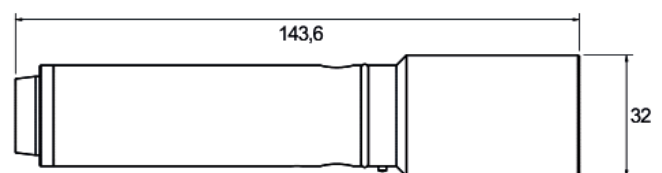
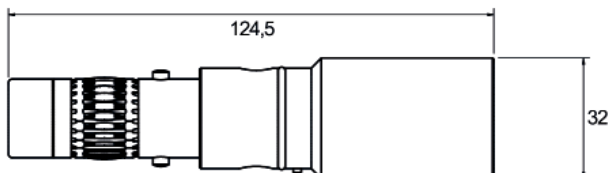

## A dual purpose system with adapters for copper and aluminium cables



SPY EasiLug is a quick, safe and easy means to fit lug terminal single core aluminium or copper cables into a classical PowerSyntax® single pole connector. It combines the reliability of a lug termination cable with the convenience of a PowerSyntax® connector. The result is an IP67 waterproof terminal block, which also enables to disconnect the line without need of any tools (this operation must be carried out in absence of voltage).

### Advantages

Super quick assembly.

Reusable to fit cables of different lengths.

Versions available for cable up to 300 mm<sup>2</sup> (aluminium or copper).

Greater versatility than any other high power single pole connection.

This grants electrical safety and easy phase identification without need of other devices.

Less maintenance than cables fitted with set screws /sleeve systems, or crimped cables.

Lug terminal cables directly fitted into mechanically keyed, color coded Power Syntax® connectors.

Standardises the single pole connections, using the same connector's body as SPX/SPZ with crimp or set screw contacts.

Quick connect cables with lug terminals into power distro devices equipped with PowerSyntax® panel-mount connectors.

### Assembling elements

Aluminium cable

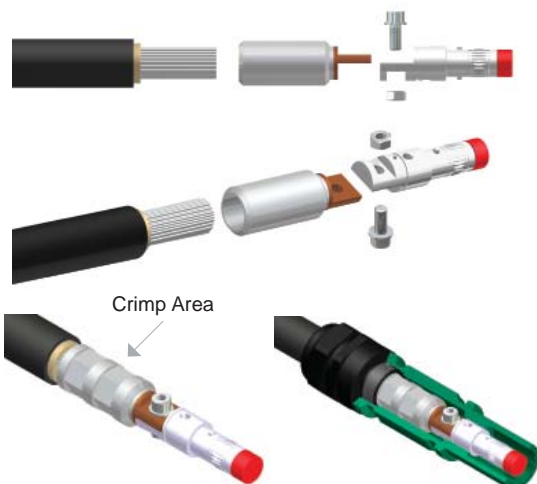

Copper cable



## Fast, safe and reliable reversal of two phase conductors

The PowerSyntax® Phase Inverters/Adaptors (up to 480amp) have been designed to solve two specific problems

- reverse the rotation direction in three-phase motors, etc... by changing the phase sequence (L1-L2-L3) between the power source and the connected devices
- provide those who use only one model of phase conductor (L1, L2 or L3) to operate L1-L2-L3+Neutral systems with an interface between standard 3-phase power generators / distros and their devices.

The former is a common demand in industrial applications.

The latter is a specific need of entertainment and cinema industries.

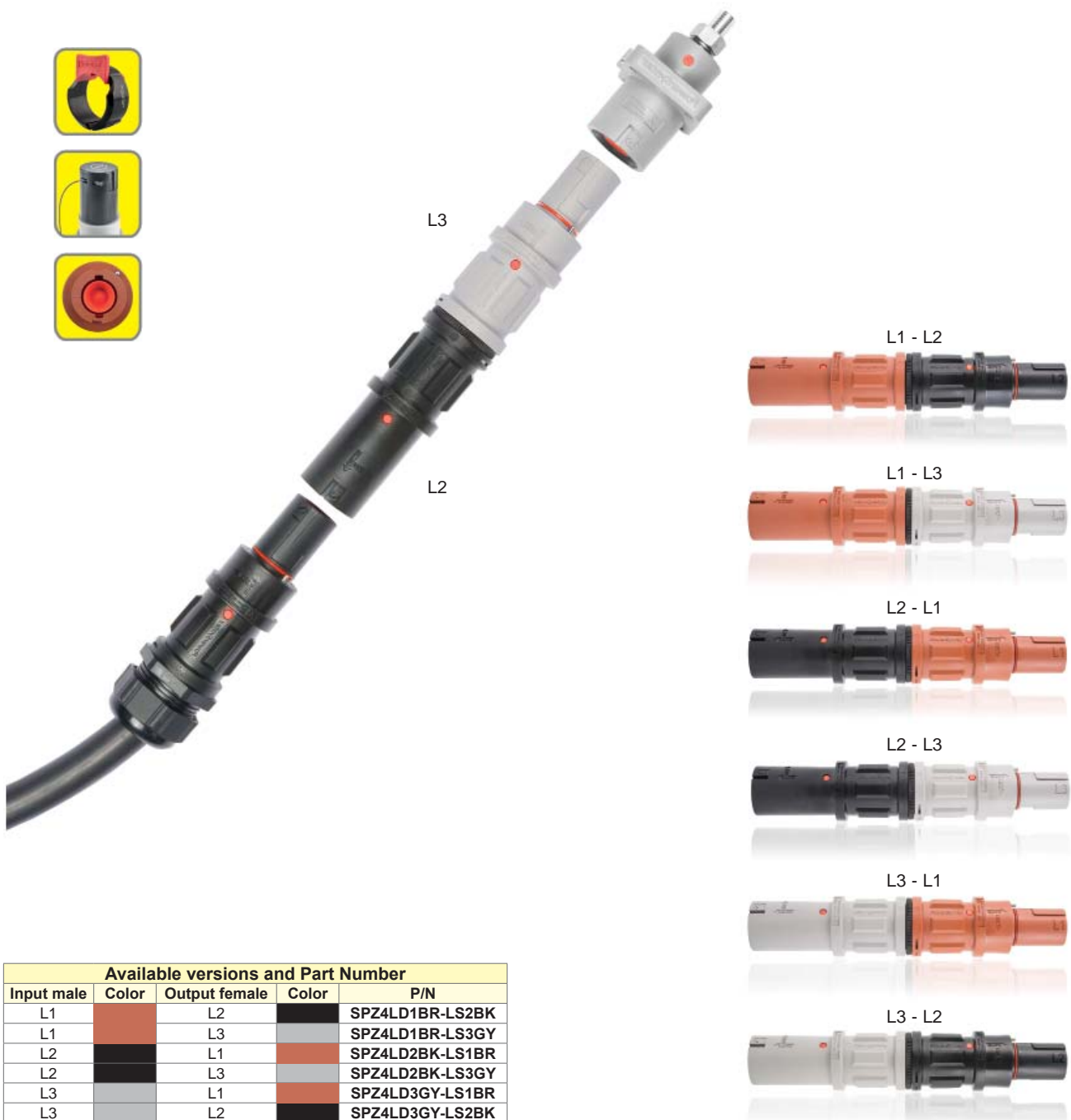

Available versions and Part Number				
Input male	Color	Output female	Color	P/N
L1	Red	L2	Black	SPZ4LD1BR-LS2BK
L1	Red	L3	Grey	SPZ4LD1BR-LS3GY
L2	Black	L1	Red	SPZ4LD2BK-LS1BR
L2	Black	L3	Grey	SPZ4LD2BK-LS3GY
L3	Grey	L1	Red	SPZ4LD3GY-LS1BR
L3	Grey	L2	Black	SPZ4LD3GY-LS2BK



## S2W 2way 480amp SPX splitter box



### TYPICAL APPLICATIONS

- All temporary electrical systems
- Power distribution
- Outdoor concerts and sports events
- Outdoor broadcasting
- Theatres, studios and film sets
- Mobile generators
- Industrial vehicles
- Railway and military installations
- Load banks
- Back-up power systems

### TECHNICAL DATA

- Rated current: 480amp, 400VCA, (Syntax® SPX 480amp).
- IP rating: IP55



## Splitter BOX S2W with Syntax® SPX 480Amp connectors

Available in stock with EU standard colours. Please contact us to learn availability for different colour standards (traditional UK, Australia and USA). Standard and reverse versions are available.

The reverse version differs from the standard only for the position where the INPUT connector is assembled (on the reverse version, the INPUT is inline with one of the OUTPUTS).



Available versions and Part Number				
1 Input male	Color	2 Output female	Color	P/N
L1	Red	L1	Red	S2WX111000S
L2	Black	L2	Black	S2WX222000S
L3	Grey	L3	Grey	S2WX333000S

nb: for the reverse version replace final "S" by "R" in the p/n  
For the version with safety lacing add "-L" at the end of the p/n

## S2W 480Amp Phase Inverter/Adaptor/Multiplier

The PowerSyntax Phase Inverters/Adaptors (up to 480A) have been designed to solve two specific problems

- reverse the rotation direction in 3-phase motors, etc. by changing the phase sequence (L1-L2-L3) between the power source and the connected devices;
- provide those who use only one model of phase conductor (L1, L2 or L3) to operate L1-L2-L3+Neutral systems with an interface between standard three-phase power generators/distros and their devices.

The former is a common demand in industrial applications. The latter is a specific need of entertainment and cinema industries. Standard and reverse versions are available (standard versions in the photo). The reverse version differs from the standard only for the position where the INPUT connector is assembled (on the reverse version, the INPUT is inline with one of the OUTPUTS).



Available versions and Part Number				
1 Input male	Color	2 Output female	Color	P/N
L1	Red	L3	Grey	S2WX133000S
L2	Black	L3	Grey	S2WX233000S
L3	Grey	L2	Black	S2WX322000S
L1	Red	L2	Black	S2WX122000S
L2	Black	L1	Red	S2WX211000S
L3	Grey	L1	Red	S2WX311000S

nb: for the reverse version replace final "S" by "R" in the p/n  
For the version with safety lacing add "-L" at the end of the p/n

## Contact and cable retention types

The PowerSyntax connectors are equipped with different contact types, depending on current rating (480amp or 750amp), cable material (aluminum or copper), connectors body type (line or panel-mount) and cable terminations.

Set screw contact



Set-screw contact, up to 480 amp. Cable retained through reduction sleeve (25-150 mm<sup>2</sup>) and set screws. Used as a standard on SPX/SPZ 480amp line source/drain connectors, the set screw contact is also available for panel-mount connectors on request.

Crimp contact



Crimp contact, up to 750 amp (all-copper contact on SPX 750amp) or 480 amp (bi-metal contact on SPV)

EasiLug contact (copper)



EasiLug contact, up to 750 amp (all-copper terminal for copper cable). Used as a standard on SPY 750amp connectors, this EasiLug contact is also available for panel-mount connectors on request.

EasiLug contact (bi-metal)



EasiLug contact, up to 480 amp (bi-metal aluminum/copper terminal) for aluminum cable. Used as a standard on SPY 480amp connectors, this EasiLug contact is also available for panel-mount connectors on request.

M12 threaded post



M12 threaded-post contact, up to 750 amp (all-copper contact) or 480 amp. Lug terminal retained through M12 nut. Used as a standard on SPX 4 and SPX 7 panel-mount connectors.

M12 threaded hole



M12 threaded-hole contact, up to 750 amp (all-copper contact) or 480 amp. Lug terminal retained through M12 bolt. Used as an alternative for M12 threaded-post contacts on SPX 4 and SPX 7 panel-mount connectors.

## IP2X drain contact safety lock

PATENTED



On the Drain connectors, the IP2X protection is obtained through a patented safety lock of the sharp-pointed insulated cap. This mechanical lock prevents improper pushing the contact inwards with fingers.



## Ergonomics



The external shell has an ergonomic design which grants optimal handling and grip, also when operating with gloves. In particular, the sides of the hand grip are specifically designed for easy pushing/pulling of the connector when mating/unmating.

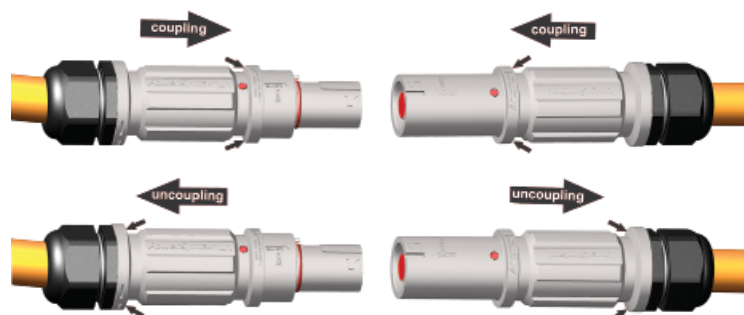

## Multilouver contact band and locking mechanism



The multilouver contact band is the core of this standard of connectors. However, on some legacy connectors, the way the contact band retention system is engineered does not ensure its positive locking. With the multilouver contact band out of its recess, the conductive surfaces will no longer be in contact, impeding the current transfer (1). To ensure the efficiency of the connection in any situation, we adopted a solution which keeps the multilouver spring loaded band in its positive location. The contact band is held in its locked position by a special ring, on which a 2.5 ton. pressure has been applied (2). This solution prevents derailment of the multilouver contact band (3).

## New threaded IP2X protection



On PowerSyntax, the touch-proof protection on source contacts features a threaded attachment for improved safety. Since this style of connectors were first introduced on the market, the typically harsh conditions of their everyday usage might result in breakage of the insulation caps, with risks for the operators' safety as the edges of the metal conductive parts remained totally exposed. Thanks to this solution, the touch-proof cap is positively threaded and then blocked with specific adhesives to make it immovable. This system reduces the risk of breakage as the bond between the protective elements and the live parts is strengthened, while improving safety for the users through reduced exposure of the metal parts, as a portion of the insulating cap will remain in its position on top of the source contact even in case of damage.

## Contact guide pin



For easy alignment of the holes on contact and insulating body, and quick insertion of the red dowel pin, the PowerSyntax contacts feature a guide pin with a corresponding recess in the insulator. With the guide pin automatically driving the contact in its correct position, the assembling operations are easier and quicker. Thanks to this solution, the contacts can be assembled even in harsh environmental situations.

After locating recess **A** in the body, find guide pin **B** on the contact, then insert guide pin **B** inside recess **A** as shown in **pic.1** For contact fastening, after locating hole **C** on the body, insert dowel pin **D** in hole **C**. Contact retention is then completed as shown in **pic. 2**



## Sleeve adapter for set screw contacts

The ultimate solution for 25 to 95 mm<sup>2</sup> cables  
Simple. Logical. Reliable.

CODE	CABLE
SPX-RED025	25 mm <sup>2</sup>
SPX-RED035	35 mm <sup>2</sup>
SPX-RED050	50 mm <sup>2</sup>
SPX-RED070	70 mm <sup>2</sup>
SPX-RED095--	95 mm <sup>2</sup>

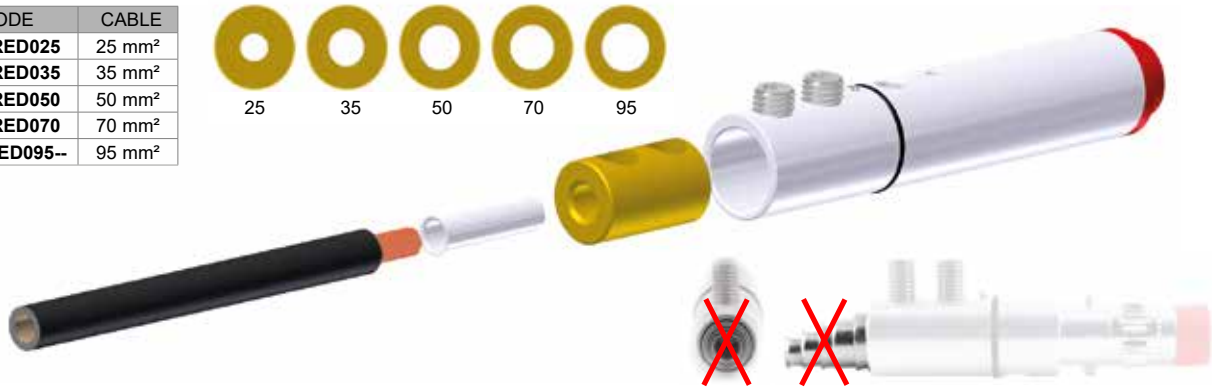

The PowerSyntax Sleeve Adapter is a unique mechanical solution for ideal cable retention when a PowerSyntax with set screw contact is used with cable sections of 95 mm<sup>2</sup> or smaller.

On other connectors commonly found on the market, multiple concentric sleeves are used to reduce the cable section from 150 or 120 mm<sup>2</sup> down to the smaller section specifically needed, with as many as 4 or 5 concentric sleeves required in case of 35 or 25 mm<sup>2</sup> sections. The thoughtful design and the mechanical reliability of the PowerSyntax sleeve adapter eliminates the need to use multiple concentric sleeves.

On the adapter, two through holes allow that set screws of a length suitable for a specific sleeve size are used, so that the compression is directly on the sleeve/cable, with no others sleeves in between. The adapter is available in different versions, each with a housing where a single reduction sleeve of the needed size is fitted.

## Cable stripping and retention



On set-screw contacts (up to 480amp power and 150 mm<sup>2</sup> cable sections), the cable is inserted into the set-screw terminal with the suitable reduction sleeve. Reduction sleeves are available for 25, 35, 50, 70, 95, 120 and 150 mm<sup>2</sup>. For all sleeve sizes, the stripping length is 33 mm (Pic. 1).



On crimp contacts (up to 750amp copper / 480amp bimetal, and up to up to 300 mm<sup>2</sup> cable sections), the position and number of cable compressions vary according to the different cable sections (see table below). Cable stripping length is 42 mm (Pic. 1).

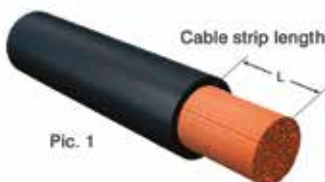

Pic. 1

	SET SCREW / REDUCTION SLEEVE	CRIMP		
Cable section	from 25 to 150 mm <sup>2</sup>	185 mm <sup>2</sup>	240 mm <sup>2</sup>	300 mm <sup>2</sup>
Cable strip length L - Pic.1	33 mm	42 mm	42 mm	42 mm
Tightening torque	12 Nm	-	-	-
Number of compressions	-	2	3	3
Hand operated hydraulic crimp tool	-	HPI130-C	HPI130-C	HPI130-C
Cordless hydraulic crimp tool	-	B1350-C	B1350-C	B1350-C
Crimp die set	-	ME 37-C	ME 60-C or U13-K28D	ME 60-C or U13-K28D



HPI130-C



B1350-C

# PowerSyntax® SPX / SPZ / SPV / SPY

SPX, SPZ, SPY and SPV are the new PowerSyntax® series of single pole electrical connectors. PowerSyntax® are specifically suited for the electrical supply management from 480amp up to 750amp (see technical data table at the bottom of this page). Although fully intermateable with the original (and all the previous Syntax® versions), the new Power Syntax® features a number of mechanical and technical enhancements which have been designed and incorporated to redefine the standards on this category of connectors as for safety, reliability, ease of handling and robustness in the harshest conditions.

## Typical applications

- Electrical power systems
- Power distribution
- Outdoor concerts and sporting events
- Outdoor broadcasting
- Theatres
- Mobile generators
- Industrial vehicles
- Railway installations
- Military installations
- Load banks
- Backup power systems
- Electrical power supply companies
- Heavy industry

## Technical data

- |  |   |
|--|---|
| • Number of contacts:  | single pole                             |
| • Max continuous current rating with brass or bimetal contact: | 480amp                                  |
| • Max continuous current rating with copper contact:           | 750amp                                  |
| • Test Voltage:  | 4500 V AC                               |
| • Short Circuit Rating:  | 35.5kA peak                             |
| • Insulation Resistance:                                       | >5000 MOhm @500V                        |
| • IP rating when mated:  | IP67                                    |
| • Protection against electric shock:                           | IP2X                                    |
| • Contact resistance:  | <0.1 mOhm                               |
| • Housing material:  | high temperature thermoplastic          |
| • Flammability:  | UL94 V0                                 |
| • Coupling method:   | bayonet lock with secondary locking pin |
| • Number of mating cycles:                                     | >500                                    |
| • Operating temperature:                                       | -30°C/+125°C                            |

## General features

- Intermateable with other versions
- CE compliant
- EN/ESI compliant
- Contact retained within the thermoplastic housing with a flame-retardant UL94-V0 plastic pin. This method ensures quick assembling and disassembling. No special extracting tools are needed
- Heavy-duty ergonomic hand grip, with sides specifically designed for easy pushing/pulling when mating/unmating
- Metric thread M40 cable gland IP68 watertight compliant with EN/CE, adapters available for cables over 32 mm diameter
- Screw, Crimp and Lug terminals to facilitate cables from 25mm<sup>2</sup> to 300 mm<sup>2</sup>
- Mechanically keyed to prevent mating errors
- Permanent marking to identify phase/line and safety information embossed on connector's body
- Multipoint contact area
- Silver Plated Contacts
- High Impact bodies
- EN harmonized color coding (Europe). Also available in UK, Australia and USA color codes

## Rated current

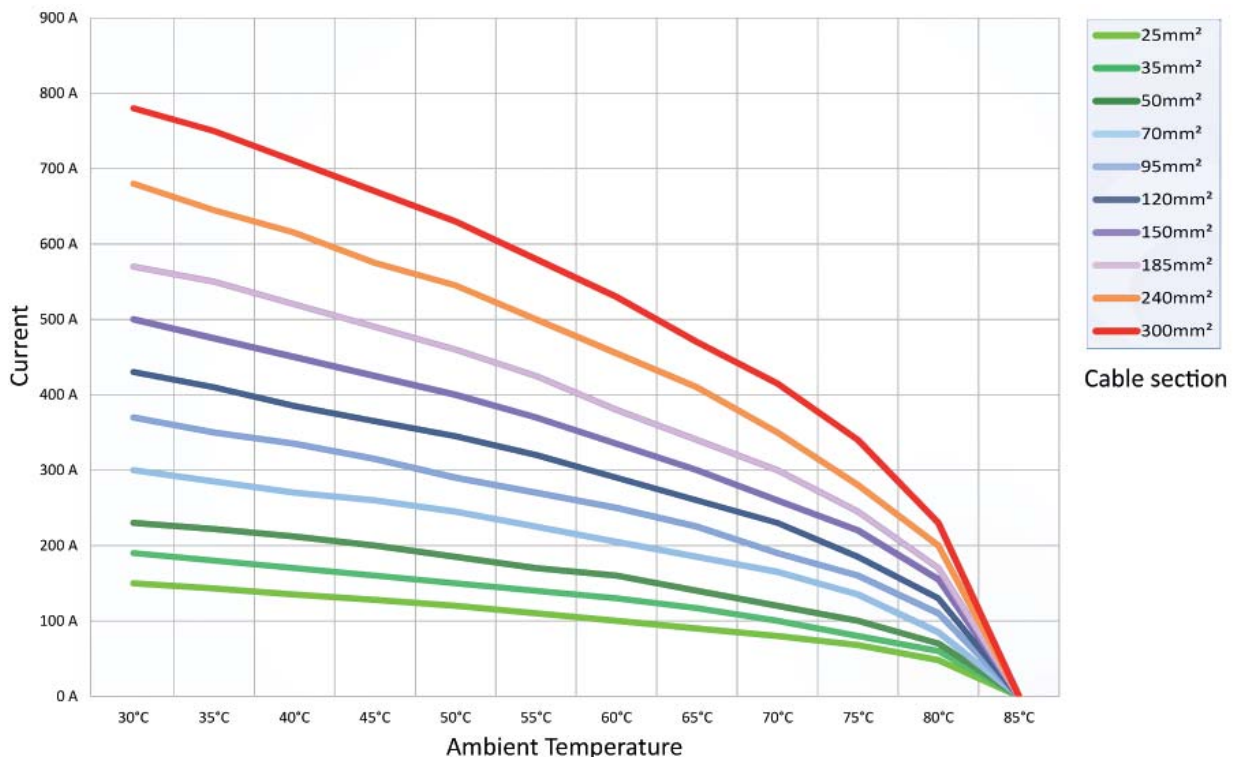

DATA FOR 90°C COPPER CABLE RATINGS (for aluminium cable, ratings decrease by approx. 25%)

## Identification color codes

	GROUND	NEUTRAL	LINE 1	LINE 2	LINE 3
EUROPE					
UK					
AUSTRALIA					
U.S.A.					

### European series example

	LINE SOURCE	LINE DRAIN	PANEL SOURCE	PANEL DRAIN
LINE 1	 LINE 1 - Line Source	 LINE 1 - Line Drain	 LINE 1 - Panel Source	 LINE 1 - Panel Drain
LINE 2	 LINE 2 - Line Source	 LINE 2 - Line Drain	 LINE 2 - Panel Source	 LINE 2 - Panel Drain
LINE 3	 LINE 3 - Line Source	 LINE 3 - Line Drain	 LINE 3 - Panel Source	 LINE 3 - Panel Drain
NEUTRAL	 NEUTRAL - Line Source	 NEUTRAL - Line Drain	 NEUTRAL - Panel Source	 NEUTRAL - Panel Drain
GROUND	 GROUND - Line Source	 GROUND - Line Drain	 GROUND - Panel Source	 GROUND - Panel Drain

# PowerSyntax® Line SPX - SPZ



## Part number explanation









Part N.							
EXAMPLE Part N.	SPX	4	LD	1	BR	120	MR

CONNECTOR SERIES	
PowerSyntax® SPX Series	SPX
PowerSyntax® SPZ Series	SPZ

MAXIMUM CURRENT RATING	
Up to 480amp SCREW (25 to 150 mm <sup>2</sup> )	4
Up to 750amp CRIMP (185 to 300 mm <sup>2</sup> )	7
Crimp contact also available from 25 to 150 mm <sup>2</sup> on request	-

CONNECTOR STYLE	
Line Drain	LD
Line Source	LS

KEY COMPOSITION	
Earth	E
Neutral	N
Phase 1	1
Phase 2	2
Phase 3	3

INSULATOR COLOR	
GREEN 	GN
BLUE 	BL
BROWN 	BR
BLACK 	BK
GREY 	GY
RED 	RD
YELLOW 	YE
WHITE 	WH

CABLE CONDUCTOR SIZE (For 25-150 mm <sup>2</sup> cables the reduction sleeves are included)	
25 mm <sup>2</sup> (SPX and SPZ series)	025
35 mm <sup>2</sup> (SPX and SPZ series)	035
50 mm <sup>2</sup> (SPX and SPZ series)	050
70 mm <sup>2</sup> (SPX and SPZ series)	070
95 mm <sup>2</sup> (SPX and SPZ series)	095
120 mm <sup>2</sup> (SPX and SPZ series)	120
150 mm <sup>2</sup> (SPX and SPZ series)	150
185 mm <sup>2</sup> (SPX series)	185
240 mm <sup>2</sup> (SPX series)	240
300 mm <sup>2</sup> (SPX series)	300

CABLE GLAND	
Reduced M40 gland Ø 15-23 mm	MQ
Normal M40 gland Ø 19-28 mm	MP
Oversized M40 gland Ø 22-32 mm	MR
M50 gland Ø 30-38 mm	MU

ACCESSORIES	
SyntaxLock quick secondary lock release system	SPX-SYLOCK
Secondary lock release key	SPXTKEY
Protective plastic cap kit for source connectors	SPXDCS-SC
Protective plastic cap kit for drain connectors	SPXD-SC
IP67 protection cap for source connectors	SPXDCS-SC-IP67
IP67 protection cap for drain connectors	SPXD-SC-IP67

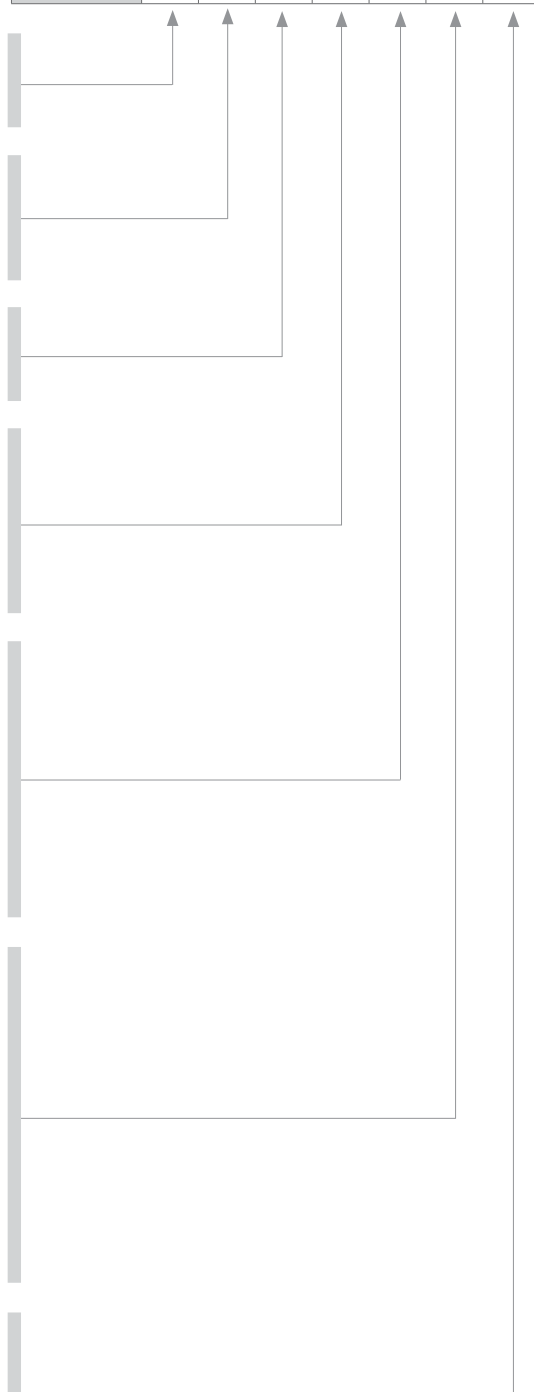





## Part number explanation

Part N.							
<b>EXAMPLE Part N.</b>	<b>SPV</b>	<b>4</b>	<b>LD</b>	<b>1</b>	<b>BR</b>	<b>120</b>	<b>MR</b>

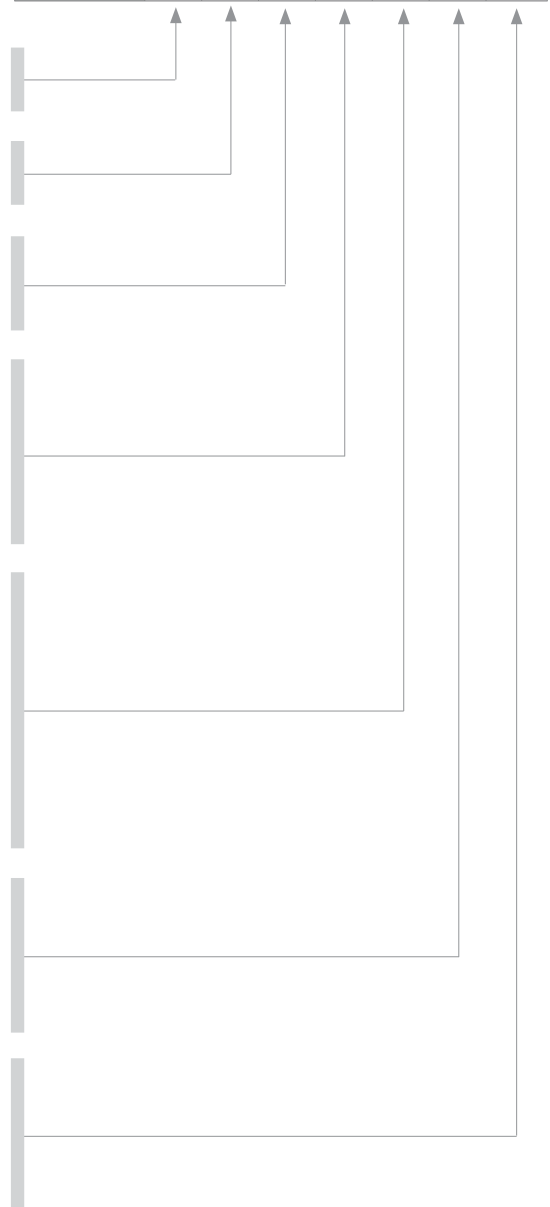









CONNECTOR SERIES	
PowerSyntax® SPV Series	<b>SPV</b>

MAXIMUM CURRENT RATING	
Up to 480amp CRIMP (120 to 240 mm²)	<b>4</b>

CONNECTOR STYLE	
Line Drain	<b>LD</b>
Line Source	<b>LS</b>

KEY COMPOSITION	
Earth	<b>E</b>
Neutral	<b>N</b>
Phase 1	<b>1</b>
Phase 2	<b>2</b>
Phase 3	<b>3</b>

INSULATOR COLOR	
GREEN 	<b>GN</b>
BLUE 	<b>BL</b>
BROWN 	<b>BR</b>
BLACK 	<b>BK</b>
GREY 	<b>GY</b>
RED 	<b>RD</b>
YELLOW 	<b>YE</b>
WHITE 	<b>WH</b>

CABLE CONDUCTOR SIZE (For 25-150 mm² cables the reduction sleeves are included)	
120 mm²	<b>120</b>
150 mm²	<b>150</b>
185 mm²	<b>185</b>
240 mm²	<b>240</b>

CABLE GLAND	
Reduced M40 gland Ø 15-23 mm	<b>MQ</b>
Normal M40 gland Ø 19-28 mm	<b>MP</b>
Oversized M40 gland Ø 22-32 mm	<b>MR</b>
M50 gland Ø 30-38 mm	<b>MU</b>

ACCESSORIES	
SyntaxLock quick secondary lock release system	<b>SPX-SYLOCK</b>
Secondary lock release key	<b>SPXTKEY</b>
Protective plastic cap kit for source connectors	<b>SPXDSC-SC</b>
Protective plastic cap kit for drain connectors	<b>SPXDSC-DC</b>
IP67 protection cap for source connectors	<b>SPXDSC-SC-IP67</b>
IP67 protection cap for drain connectors	<b>SPXDSC-DC-IP67</b>

# PowerSyntax® Line SPY EasiLug



## Part number explanation

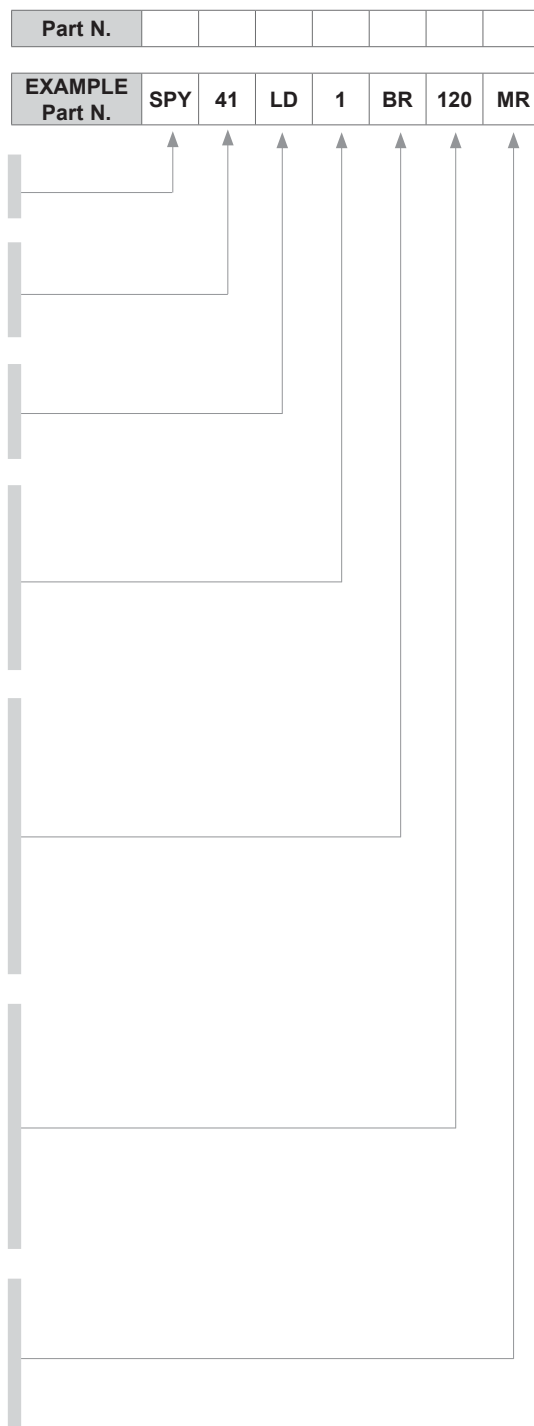









CONNECTOR SERIES	
SPY EasiLug Series	<b>SPY</b>

MAXIMUM CURRENT RATING	
For <b>aluminium</b> cable up to 480amp	<b>41</b>
For <b>copper</b> cable up to 750amp	<b>73</b>

CONNECTOR STYLE	
Line Drain	<b>LD</b>
Line Source	<b>LS</b>

KEY COMPOSITION	
Earth	<b>E</b>
Neutral	<b>N</b>
Phase 1	<b>1</b>
Phase 2	<b>2</b>
Phase 3	<b>3</b>

INSULATOR COLOR	
GREEN 	<b>GN</b>
BLUE 	<b>BL</b>
BROWN 	<b>BR</b>
BLACK 	<b>BK</b>
GREY 	<b>GY</b>
RED 	<b>RD</b>
YELLOW 	<b>YE</b>
WHITE 	<b>WH</b>

CONDUCTOR SECTION	
70 mm² copper or aluminium cable	<b>070</b>
95 mm² copper or aluminium cable	<b>095</b>
120 mm² copper or aluminium cable	<b>120</b>
150 mm² copper or aluminium cable	<b>150</b>
185 mm² copper or aluminium cable	<b>185</b>
240 mm² copper or aluminium cable	<b>240</b>
300 mm² copper cable only	<b>300</b>

CABLE GLAND	
Reduced M40 gland Ø 15-23 mm	<b>MQ</b>
Normal M40 gland Ø 19-28 mm	<b>MP</b>
Oversized M40 gland Ø 22-32 mm	<b>MR</b>
M50 gland Ø 30-38 mm	<b>MU</b>

ACCESSORIES	
SyntaxLock quick secondary lock release system	<b>SPX-SYLOCK</b>
Secondary lock release key	<b>SPXTKEY</b>
Protective plastic cap kit for source connectors	<b>SPXDCS-SC</b>
Protective plastic cap kit for drain connectors	<b>SPXD-SC</b>
IP67 protection cap for source connectors	<b>SPXDCS-SC-IP67</b>
IP67 protection cap for drain connectors	<b>SPXD-SC-IP67</b>



## Part number explanation

Part N.									
EXAMPLE Part N.	SPX	4	PD	1	BR	-	M12	CP	T5

### CONNECTOR SERIES

PowerSyntax® SPX Series	SPX
-------------------------	-----

### MAXIMUM CURRENT RATING

Up to 480amp (25 to 150 mm²)	4
Up to 750amp (185 to 300 mm²)	7

### CONNECTOR STYLE

Panel Drain M12 threaded post	PD
Panel Source M12 threaded post	PS

### KEY COMPOSITION

Earth	E
Neutral	N
Phase 1	1
Phase 2	2
Phase 3	3

### INSULATOR COLOR

GREEN		GN
BLUE		BL
BROWN		BR
BLACK		BK
GREY		GY
RED		RD
YELLOW		YE
WHITE		WH

### SPECIAL VERSIONS

M12 threaded hole contact	M12
EasyLug contact (lug terminal not included)	SPY
Set-screw drain contact (max 150 mm²)	150
Set-screw source contact (max 150 mm²)	150
Threaded body with back shell and reduced M40 gland Ø 15-23 mm	MQ
Threaded body with back shell and normal M40 gland Ø 19-28 mm	MP
Threaded body with back shell and oversized M40 gland Ø 22-32 mm	MR
Chain pilot microswitch	CP
Brass M5 threaded inserts (4)	T5

### ACCESSORIES

SyntaxLock quick secondary lock release system	SPX-SYLOCK
Secondary lock release key	SPXTKEY
Protective plastic cap kit for source connectors	SPXDSC-SC
Protective plastic cap kit for drain connectors	SPXDSD-SC
IP67 protection cap for source connectors	SPXDSC-SC-IP67
IP67 protection cap for drain connectors	SPXDSD-SC-IP67

# VALENTINI

via Asti 84/A  
10098 Rivoli (TO) - Italy

Tel +39 0119594160

[www.syntaxnet.it](http://www.syntaxnet.it)  
[info@syntaxnet.it](mailto:info@syntaxnet.it)

## SYNTAX®

is a Valentini srl registered trademark

