

PCE

Connection
to the future

Technical information



Information

CERTIFICATION ACCORDING TO EN ISO 9001 : 2008

The PCE quality management system has been certified according to the standard DIN EN ISO 9001 : 2008!

CE-MARKING - LOW VOLTAGE GUIDELINE



Purpose:

- mainly a symbol for free trade in the European Community,
- if a product has been traded legally in one of the member countries, it can be traded legally in the whole Community,
- no quality mark or grade labelling,
- no sign of conformity to standards; to a certain extent a safety mark, because it indicates the compliance to the fundamental safety requirements.



The guidelines determine only basic requirements the products have to meet.

The essential points for the CE-identification are:

- it is obligatory for the producer or the EEC importer to put on the CE-identification label,
- the producer, EEC-importer must hold the engineering data for the disposal of the authorities.
- standard marks of conformity are permissible besides the CE-identification - but no longer necessary.

APPROVALS - THE QUALITY MARKS

There has been created a CCA-method (CENELEC Certification Agreement) for mutual recognition of national approvals. PCE has tested all important products according to this method. An outline of certificates obtained is listed below for reference:



CEE and IEC

The term "CEE" generally refers to Industrial Plugs and Sockets that comply with International Standard IEC 60309. CEE is the abbreviation of "International Commission on rules for the approval of Electrical Equipment".

CONFORMITY TO STANDARDS

CEE plugs and sockets are internationally normalized by IEC 60309-1 and IEC 60309-2 equivalent to the European Norms EN 60309 part 1 and EN 60309 part 2.

IEC is the "International Electrotechnical Commission" - which is the world organization for international standardization of electrical equipment.

■ ■ CENELEC

European Committee for Electrotechnical Normalization - members are the national electrotechnical committees from Austria, Belgium, Bulgaria, Czech Republic, Croatia, Denmark, Germany, Estonia, Finland, France, Greece, Hungary, Ireland, Iceland, Italy, Latvia, Lithuania, Luxemburg, Malta, Netherlands, Norway, Poland, Portugal, Rumania, Slovakia, Sweden, Switzerland, Spain and the United Kingdom.

■ ■ SYSTEM

The standard CEE plugs and sockets according to EN 60309 respectively IEC 60309 are designed in their main dimensions in a way that plugs and sockets with the same rated currents, nominal working voltage ranges, the same number of poles and frequency of different producers are compatible.

In order to prevent the insertion of plugs and sockets of different voltages and frequencies, 12 positions of the earthing contact are assigned to the polarizing slot of the skirt of a socket.

The number with the following letter „h“ indicates the position of the earth contact tube, comparing the frontside of the socket or connector with the face of a clock. The keyway is situated at 6 o'clock (see page 11).

■ ■ ROHS — DIRECTIVE 2002/95/EG

We declare that our distribution boxes and industrial plugs and sockets as direct use, do not have to comply to RoHS directive 2002/95/EG.

For our industrial plugs and sockets (including CEE) used and or mounted into products that belong to categories 1-8 they have to comply to RoHS directive. We want to confirm that PC Electric meets all requirements of RoHS directive.

Affective Products of RoHS directive: Large household appliances, small household appliances, IT and telecommunications equipment, consumer equipment, lighting, electrical and electronic tools (except large scale stationary industrial tools), toys, leisure and sports equipment and automatic dispensers.

■ ■ PILOT CONTACT

The pilot contact for levels of current from 63A to 125A is an auxiliary contact – with delayed close when inserted and leading open when pulled – and is used as an electrical interlock. An interlock prevents inserting and pulling under load. CEE couplings and socket-outlets with pilot contact have longer phase contacts and do not guarantee safety from finger-touch. This must be done by an interlock.

As PCE CEE plugs and sockets have sufficient switching capacity, the CEE couplings and socket-outlets are supplied as standard without a pilot contact and shorter phase contact with protection from finger-touch.

Technical data:		
Kind of connection:		Screw terminals
wire	flexible [mm ²]	1 - 2,5
	solid [mm ²]	1 - 4
Contact screws [Ncm]		100 Ncm
		2A

Information

PCS (PILOT CONTACT SYSTEM):

The PCS is a built-in auxiliary contact, used only for 63A and 125A connectors and socket-outlets, for protective electrical interlocking or for additional control purposes, with isolated connection in the socket-outlet. CEE connectors and sockets have longer phase contacts and guarantee no finger protection; this must be fulfilled by a locking.

The PCS provides the following advantages:

- no special cable required for the plug
- isolated inserting and pulling

Technical Datas:

- contacts: silver-coated
- wires: 2x YF 1.5qmm 450mm

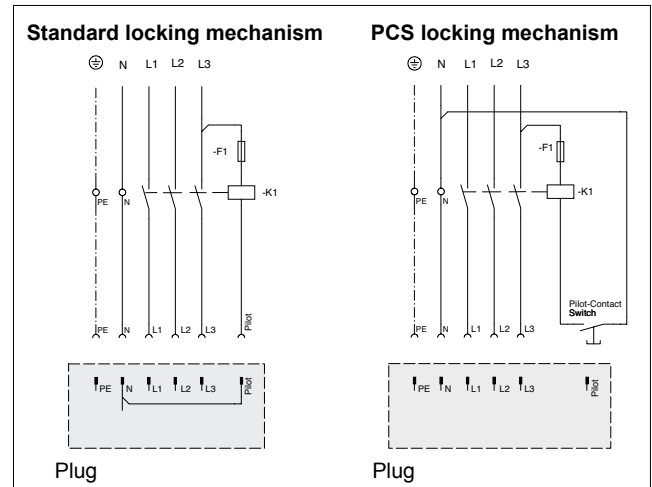

TERMINALS

PCE – connection terminals are laid out for the following cross-sections:

Connection cross-section for PCE-products		
Rated current	wire flexible [mm ²]	wire fixed (single or stranded) [mm ²]
16A	1-2,5	1-4
32A	2,5-6	2,5-10
63A	6-16	6-25
125A	16-50	16-70

Rated current	wire flexible [mm ²]	wire fixed (single or stranded) [mm ²]
P-Nova and P-Nova Plus socket	1 - 2x2,5	1 - 2x2,5
Taurus and TopTaurus plug	0,75-2,5	
Taurus and TopTaurus connector	1-2,5	
Taurus 3-way connector	1-2,5	

DISMANTLING AND STRIPPING LENGHT

Recommended datas for PCE products

Rated current	Dismantling length [mm]	Stripping length [mm]
16A	50	10-12
32A	50	12-14
63A	100	12-18
125A	100	18-20
Taurus and Top Taurus	30	7
P-Nova		10
P-Nova (screwless)		8-14
P-Nova Plus		8-10

POSITION OF THE EARTHING CONTACT ACC. TO IEC 60309-2 – SERIE I

Voltage V	Frequency Hz	2P+E		3P+E		3P+N+E	
		16+32A	63+125A	16+32A	63+125A	16+32A	63+125A
57/100 to 75/130	50 and 60					4	4
100 to 130	50 and 60	4	4	4	4		
120/208 to 144/250	50 and 60					9	9
200 to 250	50 and 60	6	6	9	9		
200/346 to 240/415	50 and 60					6	6
220/380 250/440	50 60					3	3
250/440 to 265/460	60					11	11
277/480 to 288/500	50 and 60					7	7
347/600 to 400/690	50 and 60					5	5
380 to 415	50 and 60	9	9	6	6		
380 440	50 60			3	3		
440 to 460	60			11	11		
480 to 500	50 and 60	7	7	7	7		
600 to 690	50 and 60			5	5		
> 50	100 to 300	10	10	10	10	10	10
> 50	>300 to 500	2	2	2	2	2	2
> 50 to 250	DC	3	3				
> 250	DC	8	8				
supply by isolating transformer	50 and 60	12	12	12	12	12	12
Others		1	1	1	1	1	1

COLOUR CODES

For ease of identification of the various voltages and frequencies all CEE plugs and sockets are colour coded:

Rated operating voltage:	Colour code:
20-25V	violet
40-50V	white
100-130V	yellow
200-250V	blue
380-480V	red
500-690V	black
> 60-500Hz	green
no colour code	grey

INTERNATIONAL RATING – SERIE I

for appliances >50V - details see table above

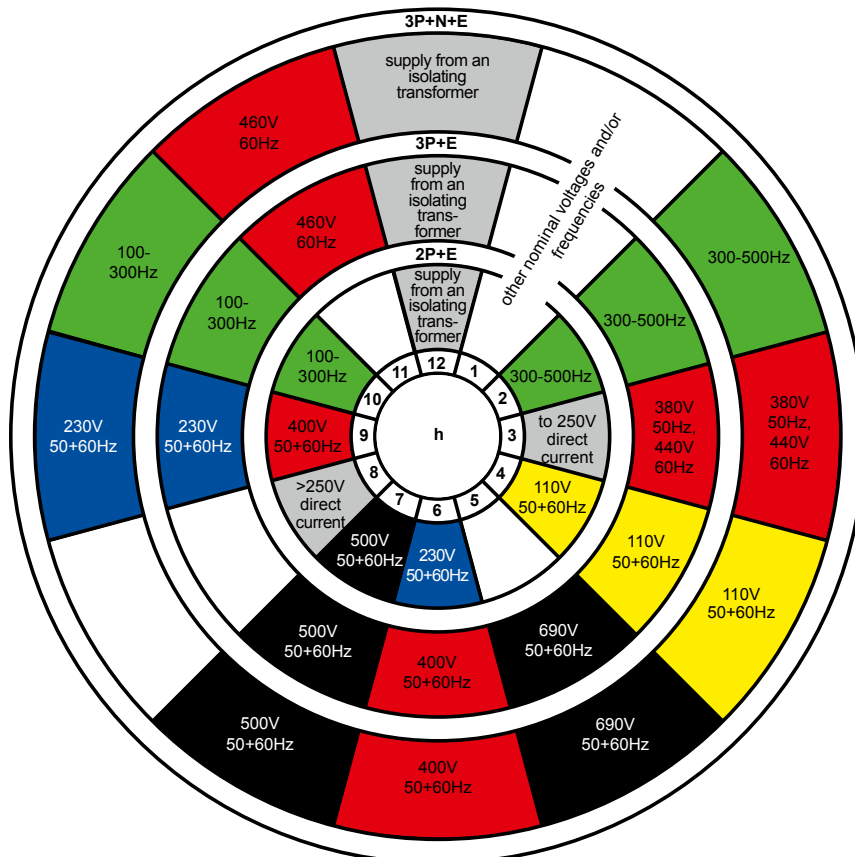

Position of the earthing contact.
View: frontside socket or connector

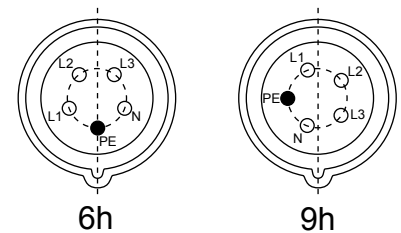

* non standard
** non standard for 63A, 125A

Information

LOCKING DEVICE

A locking device prevents unintended withdrawal by locking the hinged lid in a lug/cavity or a bayonet system with a bayonet ring. According to EN 60309 the following locking devices have to be provided:

rated current	protection degree	sockets and connectors	plugs and appliance plugs
16A and 32A	IP44	hinged lid	lug/cavity
16A and 32A	IP67	bayonet system	lug/cavity and bayonet ring
63A and 125A	IP67	bayonet system	bayonet ring

Extract from the standard EN60309 for plugs and flanged plugs

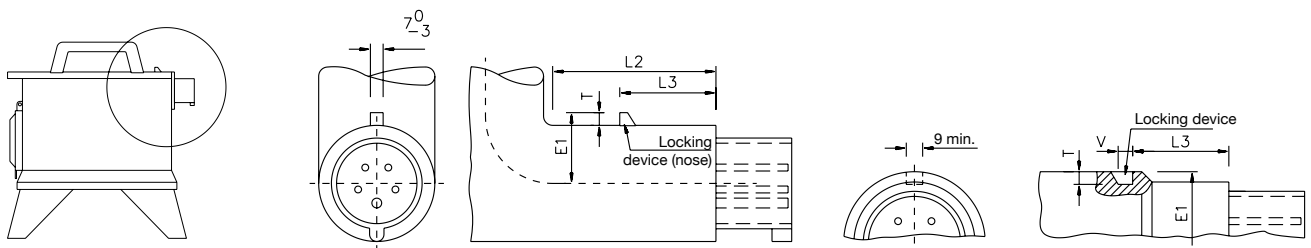

Positioning table (in mm):

		E1	L2	L3	T	V
16	3	29-31	≥75	40-41	≥4	≥8
16	4	33-35	≥80	46-47	≥5	≥8
16	5	37-39	≥90	52-53	≥7	≥8
32	3	39-41	≥90	53-54	≥7	≥8
32	4	39-41	≥90	53-54	≥7	≥8
32	5	44-46	≥105	59-60	≥8	≥9

IP (INGRESS PROTECTION) - RATINGS

CEE-plugs and sockets with rated currents 16A and 32A must meet the system of protection IP44 or IP67; 63A and 125A protection degree IP66/67 according to EN 60529.

The degree of protection is tested:

- on sockets and connectors, with and without inserted plug or appliance plug
- on plugs and appliance plugs, when fully inserted into the socket or connector.

1st digit	Protection against ingress of solid objects	2nd digit	Protection against penetration of water
2	∅ 12,5 mm	0	non protection
3	∅ 2,5 mm	3	spraying water at an angle up to 60° from the vertical
4	∅ 1 mm	4	splashing water from any direction
5	dustproof	5	water jets from any direction
6	dust-tight	6	strong water jets from any direction
		7	temporary immersion in water
		8	continuous submersion in water

Example: **IP44** = **1st digit** = 4 . protection against solid objects larger than 1mm ∅
2nd digit = .4 protection against splashing water from any direction

■ ■ IK-CODE:

The IK code is a coding system according to ICE/EN 50102, which defines the degree of protection provided by an enclosure against damaging mechanical loads.

Each characteristic numerical group of the IK Code represents a load energy value as per the table:

IK-Code	IK01	IK02	IK03	IK04	IK05	IK06	IK07	IK08	IK09	IK10
Load energy in joule	0,14	0,2	0,35	0,5	0,7	1	2	5	10	20

■ ■ PLASTIC MATERIAL

Our plugs and sockets are produced from **POLYAMIDE 6**. The main characteristics of this material are:

- excellent impact resistance combined with high rigidity and solidity,
- high thermal stability (self-extinguishing),
- very good insulating qualities,
- high disruptive strength,
- high abrasion resistance,
- high weathering resistance,
- very good chemical resistance to various chemicals,
- free from cadmium and halogen (fluorine, chlorine, bromine, iodine, astatine)
- conform to RoHS-directiv 2011/65/EU (page 9)

PCE - overview chemical resistance:

Chemicals	Concentration	Resistance	
		PA6	PC/ABS
acetone		+	-
aldehyde		o	-
alcohols		+	+
formic acid	4-5%	-	o
amine		+	-
ammonia	5%	+	o / -
ammonium chloride	35%	+	-
inorganic salts		+	o
benzine		+	+
benzol		+	o
chlorine		o	o
acetic acid	5%	o	+
ester		+	o
ethyl aether		+	o
fats		+	+
hydrofluoric acid		-	o
formaldehyde	5%	+	-
formalin	3-4%	+	-
glycol		o	o

Chemicals	Concentration	Resistance	
		PA6	PC/ABS
glycerin		+	o
calcium hydroxide	50%	o	-
ketone		+	-
fuels		+	o
methane		+	x
petroleums		+	+
sodium chloride		+	+
sodium hydroxide	10%	+	x
sodium hydroxide	2-8%	+	-
nitrobenzene		+	-
oils		+	+
phosphoric acid	10%	-	o
propanol		+	o
nitric acid	2%	-	+
hydrochloric acid	2%	-	o
sulfuric acid	50%	-	+
water		+	+
hydrogen peroxide	30%	o	+
citric acid	20%	o	+

+ resistant o conditionally resistant - not resistant x not specified

The information about the resistance is valid with ambient temperature and can lead in coincidence of different media to different resistances.

Source: Saechtling Kunststoff pocket book; Carl Hanser Verlag Munich, Vienna and DSM Engineering plastics

Information

CONTACTS

The contacts are made of a copper-zinc alloy. The most important features are:

- high electric conducting capacity 15m/(Ohm mm²);
- high resistance to extension up to 103 kN/mm²);
- high corrosion resistance in areas of: industrial atmosphere, agriculture , . . .
- with nickel-plated contacts increased corrosion resistance in areas of: seawater, steam, sulphur hydrides, agriculture, dairies.
- conform to RoHS-directiv 2002/95/EG (page 9)
- PCE sockets 63A and 125A have a CuBe lamellar spring for a well contacting and anti-corrosion contacts (page 17).

TEMPERATURES





IEC/EN 60309 applies to CEE plugs and sockets which are used at an ambient temperature that does not normally exceed the range from -25°C to +40°C. PCE CEE plugs and sockets themselves have an operating temperature of -25°C to +80°C (100°C for 1 hour).













The temperature of the contacts is allowed to rise by 50°C under the test conditions set out in Table 8.

Operating current A	Test duration h	Test current A	Cross section of the conductors	
			Plugs, and connectors mm ²	Sockets mm ²
			16	1
32	1	42	6 ¹⁾	10
63	2	63	16	25
125	2	125	50	70

¹⁾ The values are increased to 10mm² for plugs and sockets with up to 50V rated operating current.

TORQUES FOR PCE PRODUCTS

Rated current	Series		Torques [Ncm]
16A	Cable gland		400
	Housing screws		110
	Connecting screws		180
	Cable gland >50V		600

Rated current	Series		Torques [Ncm]
32A	Cable gland		500
	Housing screws		110
	Connecting screws		180
	Cable gland >50V		600
63A	Cable gland		1300
	Connecting screws		200
	Housing screws		200
	Connecting screws		200
125A	Cable gland		1400
	Connecting screws		200
	Housing screws		200
	Connecting screws		200



16/32A

LET'S TAKE **TWIST** - IT'S EASY QUICK AND SAVE

■■■ TWIST

Contact screws

- accessible from one direction
- captive and open
- with multi-slot

No screws needed to assemble the plug

- multi-ramp quick-lock system
 - easy fitting by twist-lock action
- saves your time

Dismantling

- simply unlock and twist to open

■■■ ADVANTAGES OF THE NEW CABLE LOCK GLAND

- saves time
- simply insertion of the cable in less time
- strain relief and sealing of the cable by tightening the cable-lock gland
- self-adjusting gasket for different cable diameters
- maximum cable security

■■■ TURBO TWIST



1) Insert wire

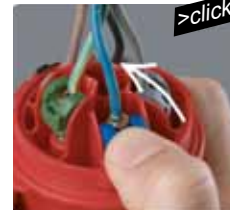

2) Close terminal



3) Reopen terminal

Screwless connection technology

- Time saving
- Screwless TT-terminal (PCE-patent in process)
- Open contact terminals, ready for assembly
- Fast cable installation
- Simple closing and opening just by thumb pressure

For all standard cable diameters

- 16A: from 2,5mm² flexible to 4mm² solid stripped wires
- 32A: from 6mm² flexible to 10mm² solid stripped wires

Flexible stripped wires

- with or without end sleeve or solid stripped wires

63/125A

SAFETY

HEAVY DUTY

TIME SAVING

■■■ SAFETY

Lamellar spring

- low insertion and extraction forces
- minimum contact resistance
- self-cleaning
- optimum contact - at least 10 contact points

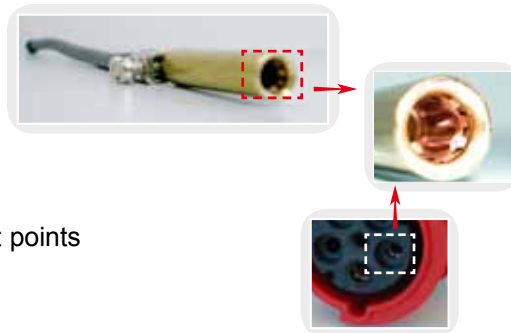

TWIST-cable gland

- secures the cable firmly in position
- protects from water and dust
- Safety screw locks the screw cap in position



POWER
TWIST



■■■ HEAVY DUTY

For extreme environments

Exceptional high impact resistance

Extreme heat resistant contact carriers

Anti-corrosion contacts

- offer protection in aggressive atmospheres, e.g. in chemical plants, food industries

■■■ TIME SAVING

TWIST-cable gland

Optimum grip

Wide connection space

- fast cable installation

**Open contact terminals,
ready for assembly**

PCE

Connection
to the future

www.pcelectric.at **PC Electric GesmbH**

Diesseits 145

4973 St. Martin im Innkreis

AUSTRIA

TEL +43 7751 61220

FAX +43 7751 6969

office@pcelectric.at